

CityGML Utility Network ADE – Scope and current work

Tatjana Kutzner, Thomas H. Kolbe

Chair of Geoinformatics
Technical University of Munich

kutzner@tum.de, thomas.kolbe@tum.de

MUDDI ETL-Plugfest Workshop
New York, July 24, 2018

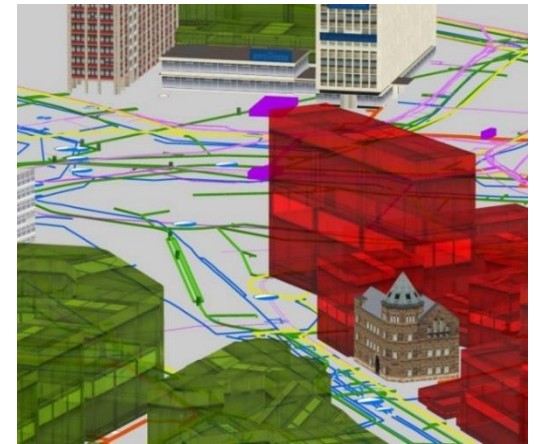

Modeling Critical Infrastructures

Integrated 3D modeling of multi-utility networks and their **interdependencies** for critical infrastructure analysis

Integrated Modeling:

- ▶ Geometric, topological & functional modeling of network entities
- ▶ Dual representation: topographic 3D model **and** functional model
- ▶ Simultaneous representation of heterogeneous utility networks
- ▶ Hierarchical modeling on the feature **and** network level

Interdependencies:

- ▶ Explicit relations between network entities and other city model objects
- ▶ Explicit relations between network entities of different kinds of commodity

Analyses:

- ▶ **Joint visualisation** of 3D city model and 3D utility networks
- ▶ **Impact analysis:** propagation of breakdowns across multi-utilities, determination of cascading effects, estimation of the no. of affected citizens

Integration of Utility Networks into the 3D City Model

- **Goal:** Development of a homogenized 3D network model for multi-utility failure simulation including the relevant thematic attribution (usage type, commodity, materials, operating parameters, no. of affected citizens etc.)

SEMANTIC
3D CITY MODEL



HIGH RESOLUTION
DIGITAL TERRAIN MODEL



UTILITY INFRASTRUCTURE
OF TYPE A
(E.G. ELECTRICITY)



UTILITY INFRASTRUCTURE
OF TYPE B
(E.G. WATER)

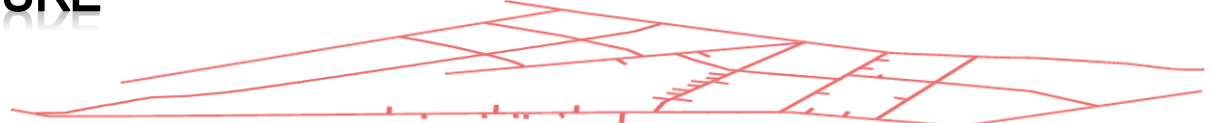
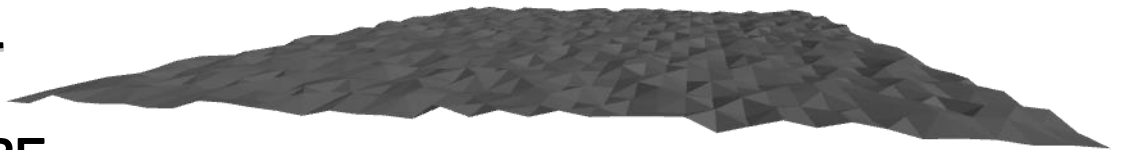

→ CityGML Utility Network ADE



Integration of Utility Networks into the 3D City Model

Example

- ▶ LoD 1 Buildings
- ▶ Networks
 - Freshwater
 - Electricity
 - Wastewater

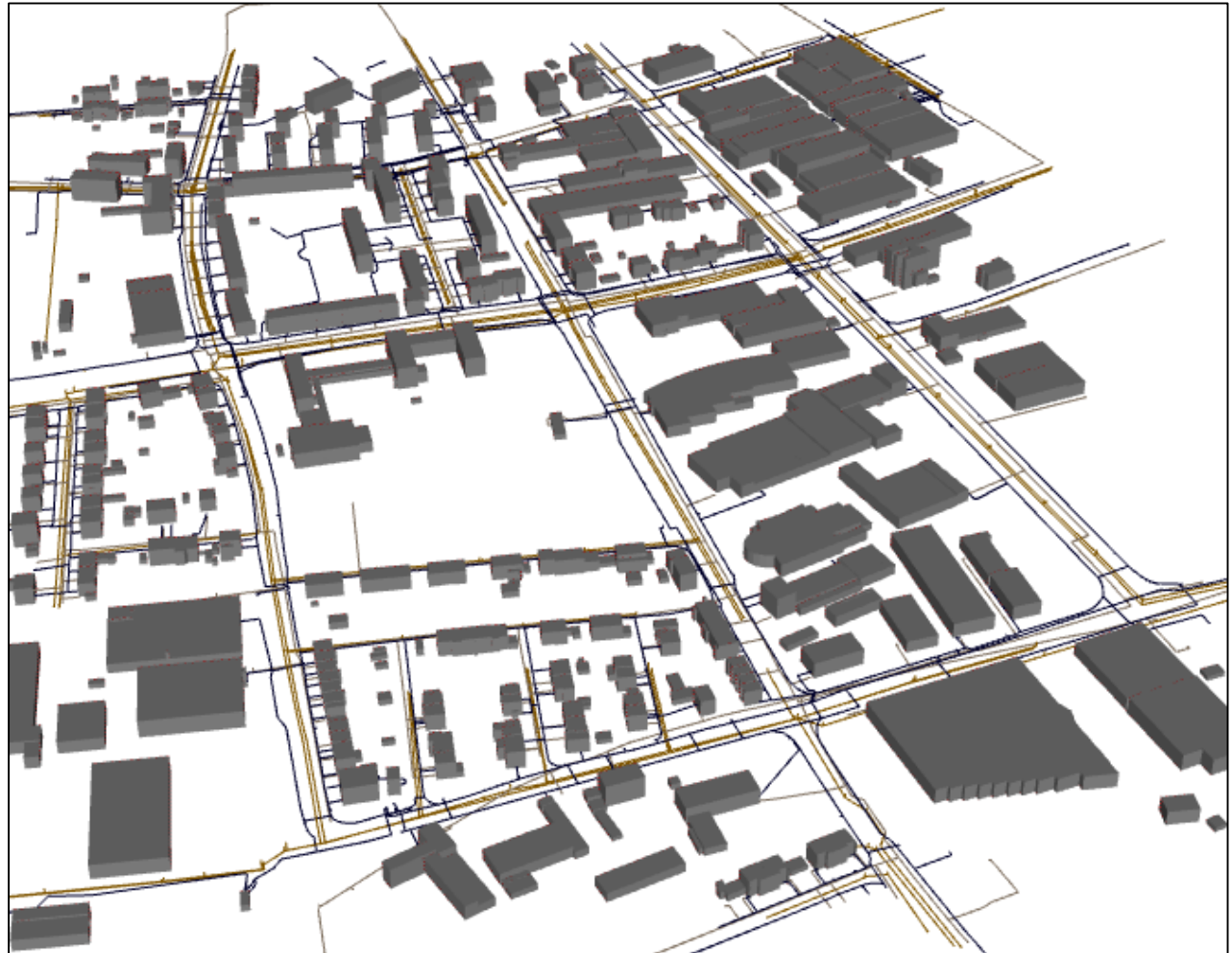

2D/3D Analyses & Simulations

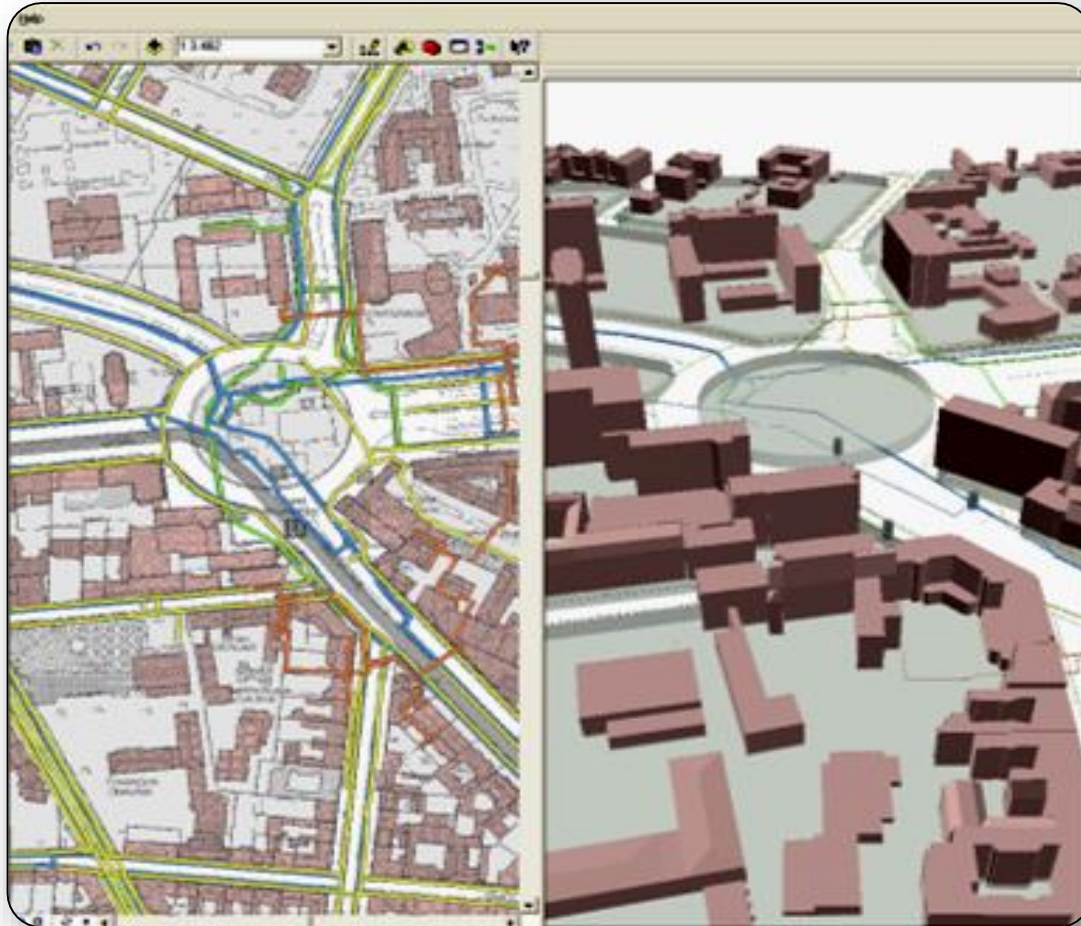
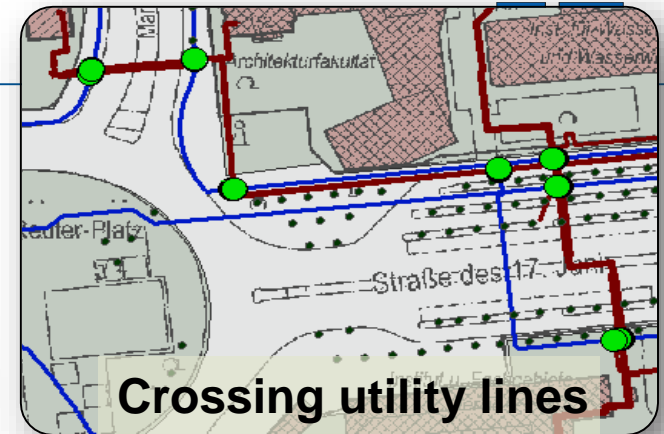
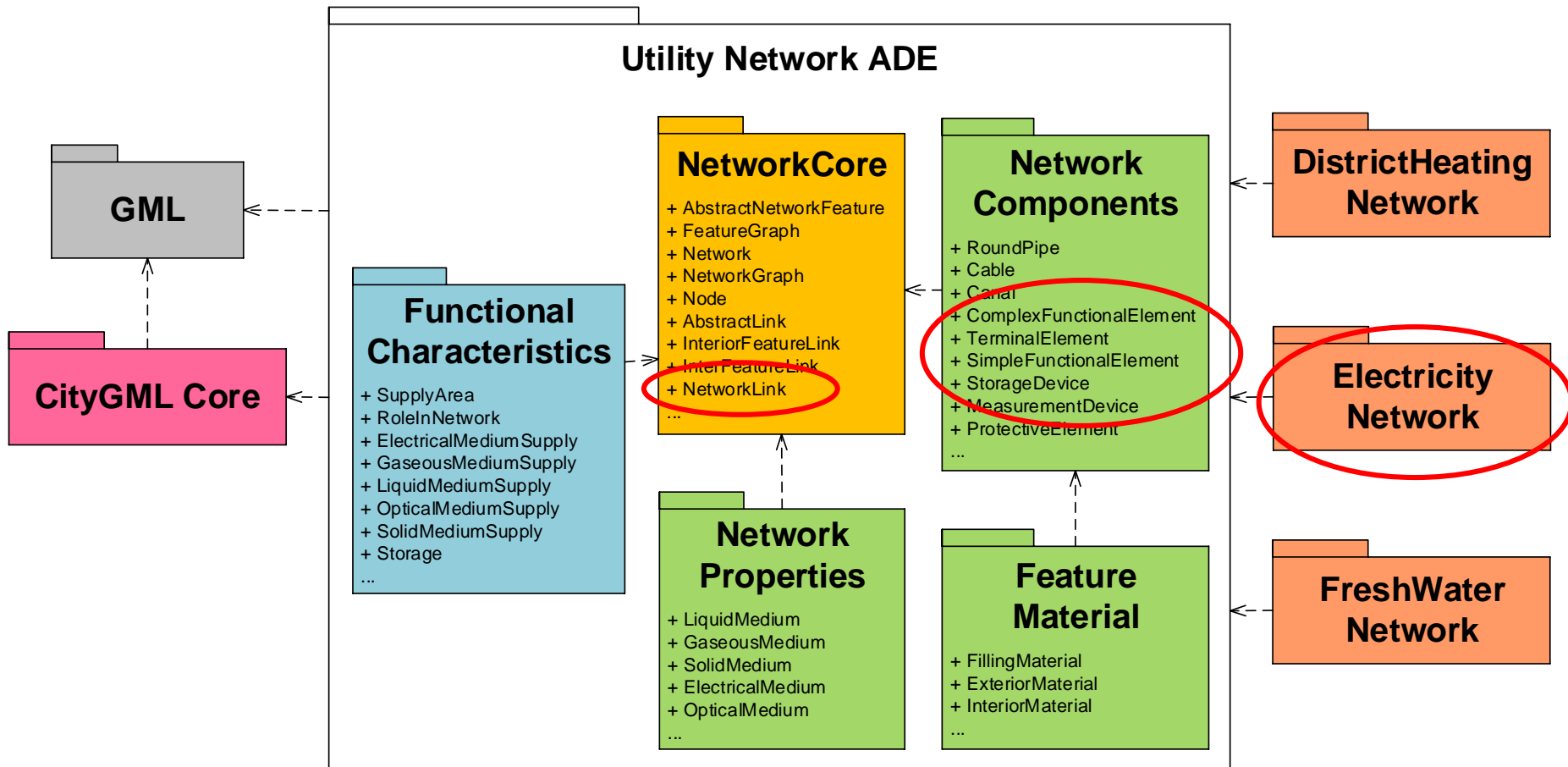

Image: DHI-WASY GmbH, SIMKAS 3D project partner



CityGML Utility Network ADE

- ▶ The **CityGML Utility Network ADE** extends CityGML by the possibility to represent supply and disposal networks in 3D city models



Complete Network

Core Model in UML

Topography

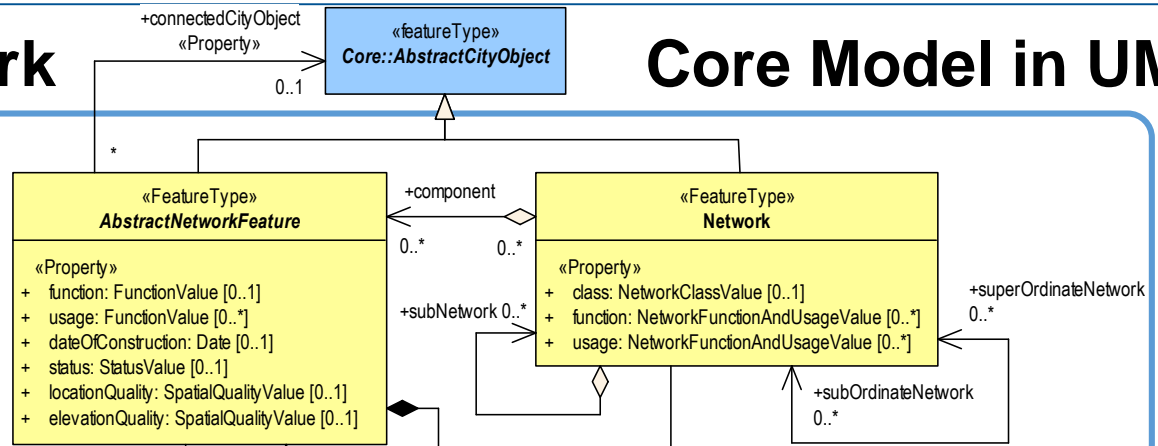

Graph Representation

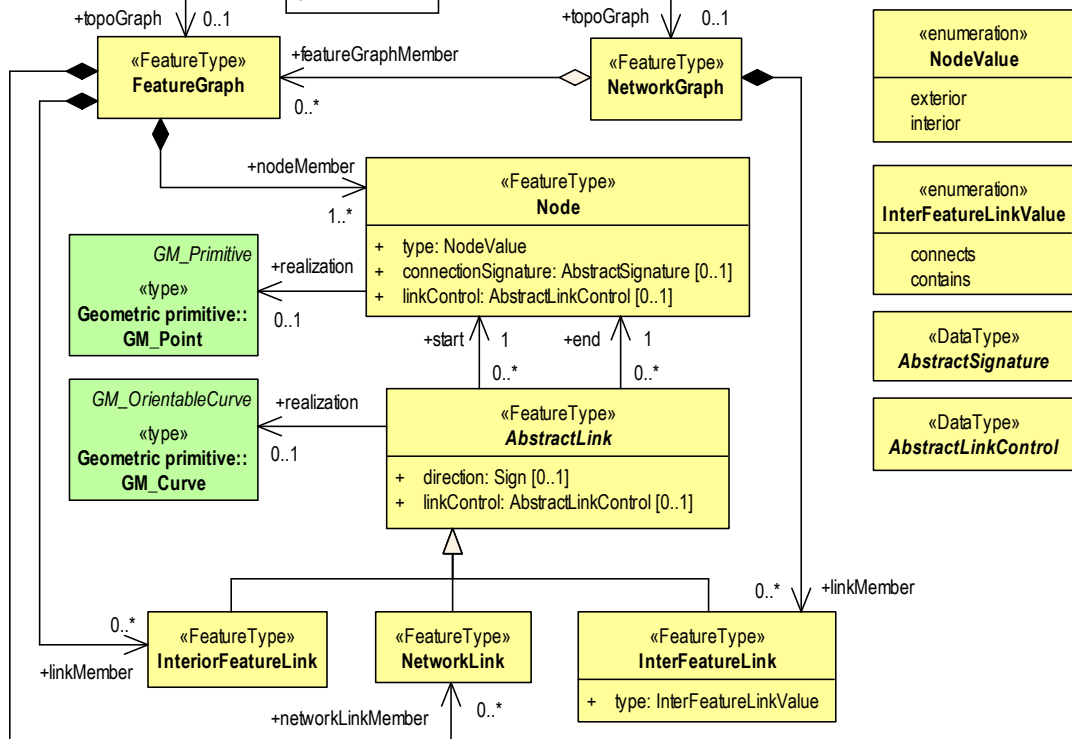

Network link

- ▶ Network links can be used to express a functional relationship between
 - different subnetworks of the same type (e.g. two circuits in an electrical network)
 - different networks of different types (e.g. between water and electricity network)

- ▶ The following slides give some examples of network components which act as network link between networks and are to serve as basis for further discussion

Network link example (I) – Transformer

- ▶ Network link between two subnetworks of the same type

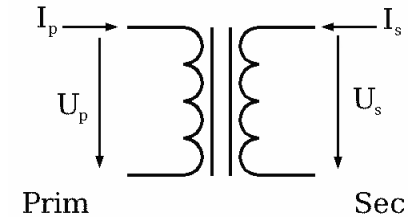
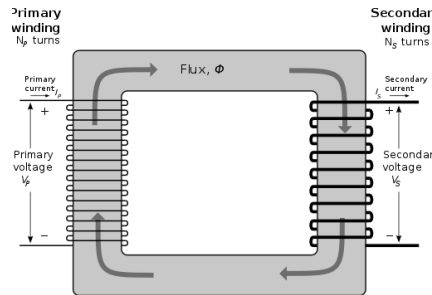
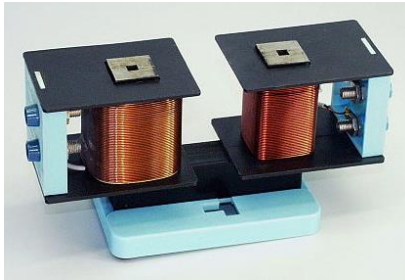

- ▶ Representation options using the Utility Network ADE

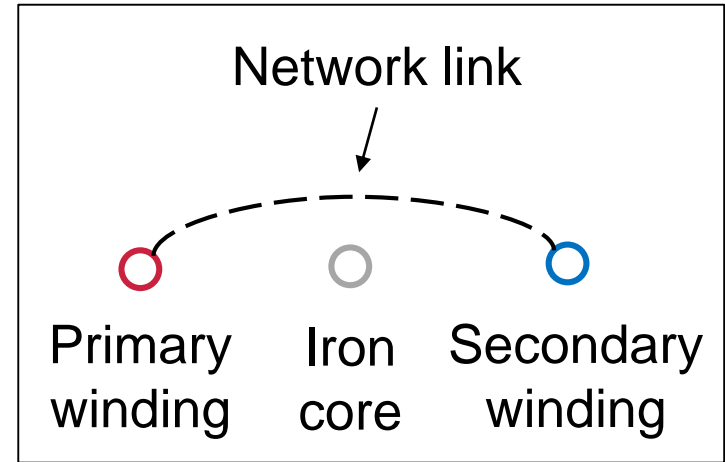
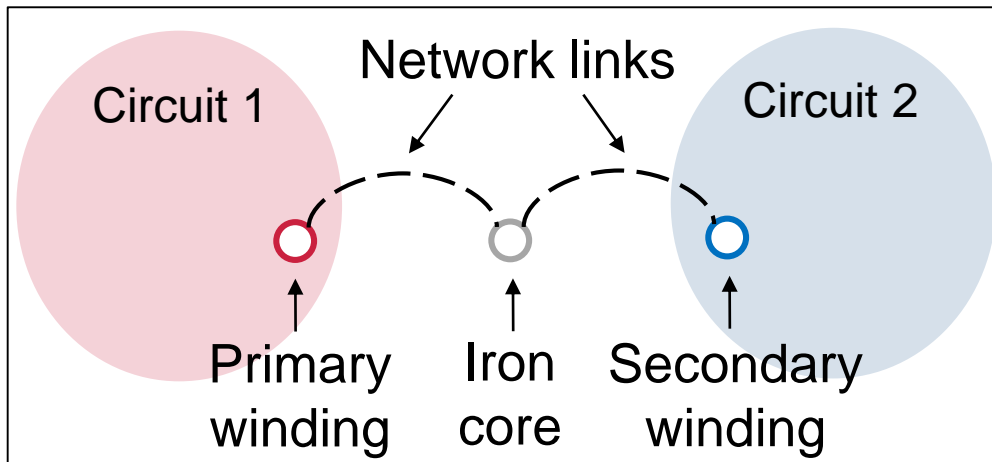

Zátonyi Sándor (ifj.), Fizedp (https://commons.wikimedia.org/wiki/File:Trafo_3.jpg), „Trafo 3“, <https://creativecommons.org/licenses/by-sa/3.0/legalcode>
 No machine-readable author provided. BillC assumed (based on copyright claims). (https://commons.wikimedia.org/wiki/File:Single-phase_transformer.svg), „Single-phase transformer“, marked as public domain
 Dirk-Lüder Kreie (https://commons.wikimedia.org/wiki/File:Schaltbild_Trafo.png), „Schaltbild Trafo“, <https://creativecommons.org/licenses/by-sa/3.0/legalcode>

Network link example (II) – Transformer with multiple secondary windings

- ▶ A functional relationship exists between three subnetworks, which is established by the iron core
- ▶ With the network links we want to express e.g. that by switching off network 1 (primary winding), no electrical power is induced any more in the secondary windings

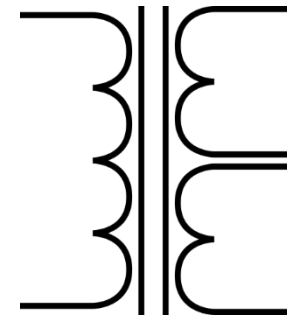

- ▶ Representation options using the Utility Network ADE

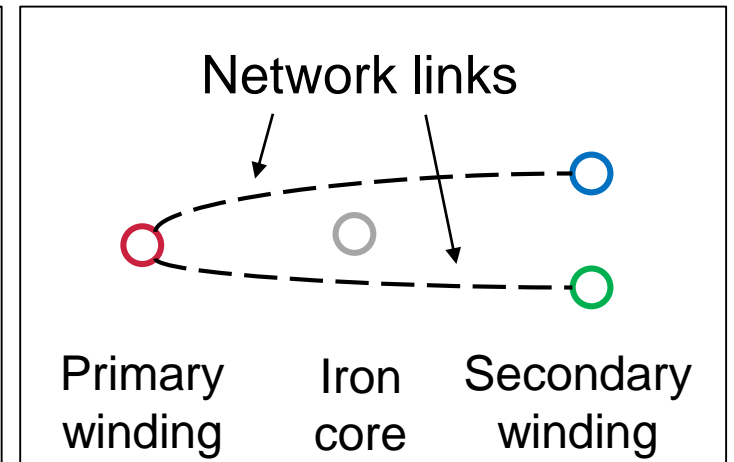
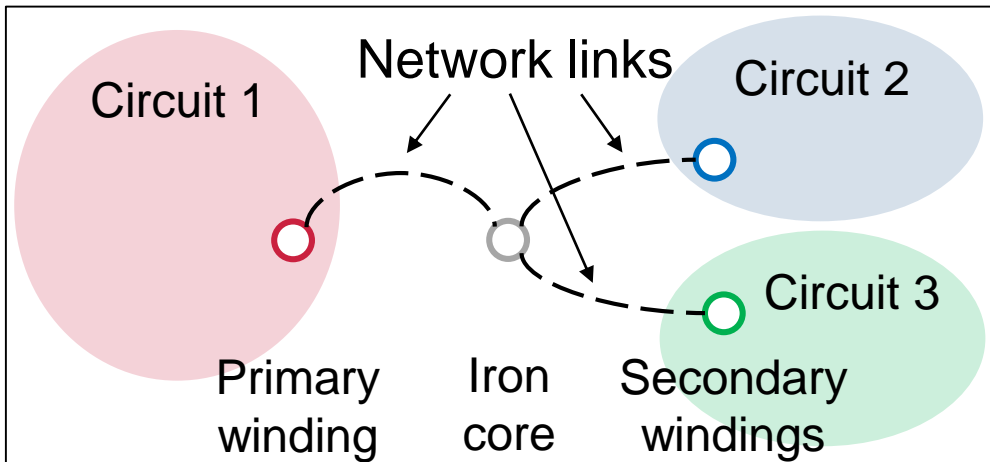

ErikBuer (https://commons.wikimedia.org/wiki/File:Transformer_two_secondary_windings.svg), <https://creativecommons.org/licenses/by-sa/4.0/legalcode>

Network link example (III) – Heat exchanger

- ▶ Network link between networks of different types (liquid/liquid, liquid/gas, gas/gas)

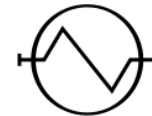
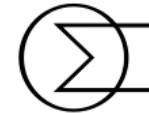
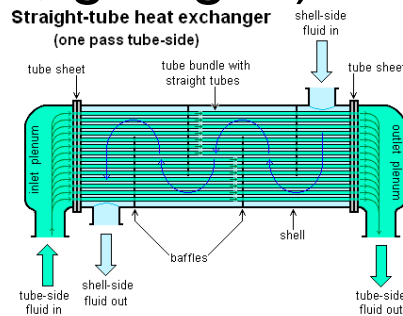

- ▶ Representation using the Utility Network ADE

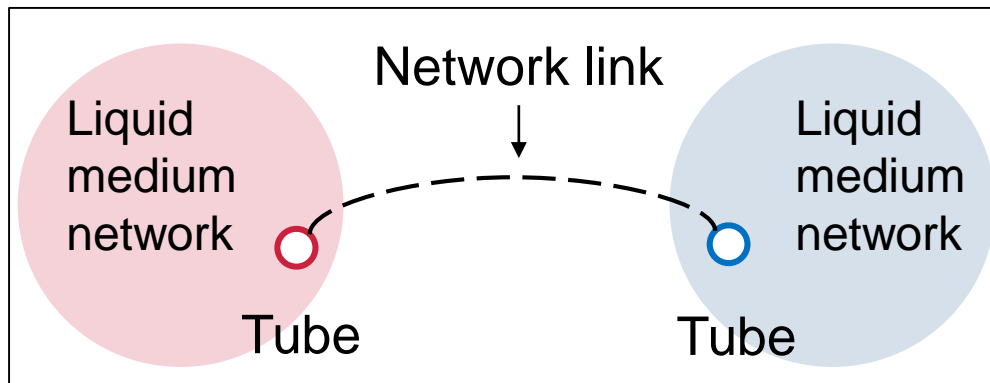

Salessupport2 (https://commons.wikimedia.org/wiki/File:Spiral_Plate_Heat_Exchanger_Type_3.jpg), <https://creativecommons.org/licenses/by-sa/4.0/legalcode>
 H Padleckas (https://commons.wikimedia.org/wiki/File:Straight-tube_heat_exchanger_1-pass.PNG), „Straight-tube heat exchanger 1-pass“, <https://creativecommons.org/licenses/by-sa/3.0/legalcode>
 Snipre (https://commons.wikimedia.org/wiki/File:Heat_exchanger_no_cross.svg), „Heat exchanger no cross“, marked as public domain
 Snipre (https://commons.wikimedia.org/wiki/File:Heat_exchanger_with_cross.svg), „Heat exchanger with cross“, marked as public domain

Network link example (IV) – Electrical pump

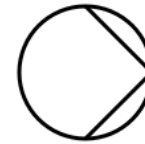
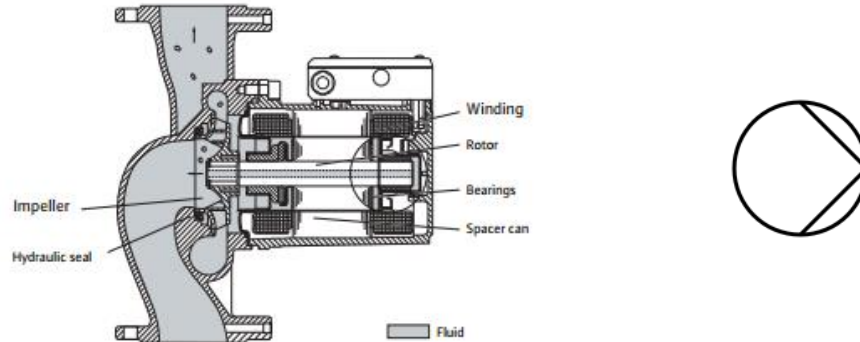

► Representation by the Utility Network ADE

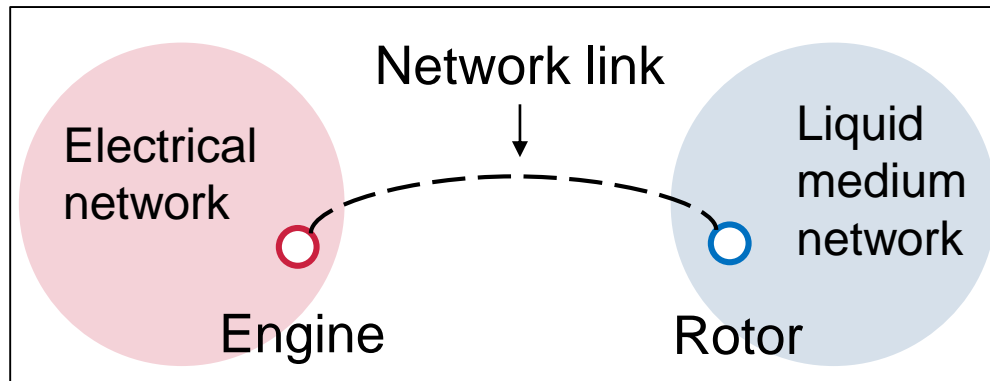

KVDP (https://commons.wikimedia.org/wiki/File:Jet_pump.jpg), „Jet pump“, marked as public domain
 wilo se (https://commons.wikimedia.org/wiki/File:Pump_diagram.PNG), „Pump diagram“, <https://creativecommons.org/licenses/by-sa/3.0/legalcode>
 Snipre (<https://commons.wikimedia.org/wiki/File:Pump.svg>), „Pump“, marked as public domain

Network link example (V) – Heat pump

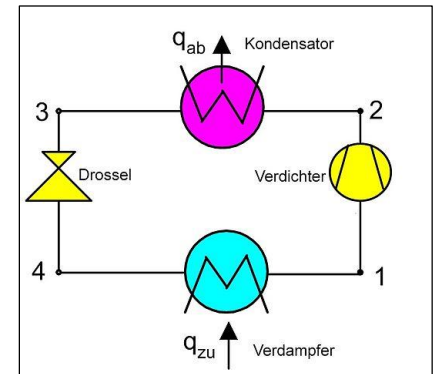
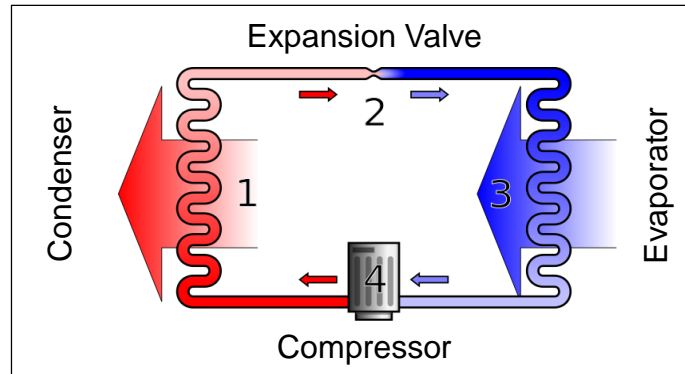

Connects three networks

1. Electricity connection (compressor)
2. Low temperature connection (heat exchanger)
3. High temperature connection (heat exchanger)

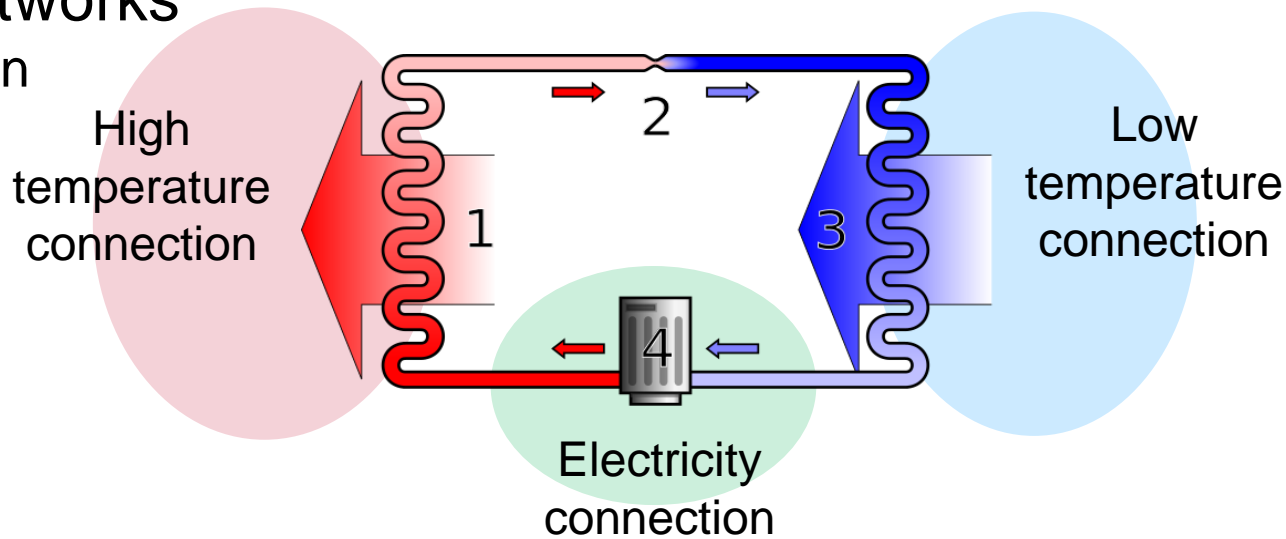

Reinraum (https://commons.wikimedia.org/wiki/File:Absorption_heat_pump.jpg), „Absorption heat pump“, marked as public domain
 Ilmari Karonen (<https://commons.wikimedia.org/wiki/File:Heatpump2.svg>), „Heatpump2“, marked as public domain
 Volker Sperlich (<https://commons.wikimedia.org/wiki/File:WP-Schaltbild-.jpg>), „WP-Schaltbild-“, <https://creativecommons.org/licenses/by-sa/2.0/de/legalcode>

NetworkLink – Representation in data set

```
<FeatureGraph>
```

```
  <linkMember>
```

```
    <NetworkLink gml:id="networklink1">
```

```
      <utility:start xlink:href="node1"/>
```

```
      <utility:end xlink:href="node2"/>
```

```
    </NetworkLink>
```

```
  </linkMember>
```

```
  <nodeMember>
```

```
    <Node gml:id="node1">
```

```
      <type>exterior</type>
```

```
    </Node>
```

```
  </nodeMember>
```

```
  <nodeMember>
```

```
    <Node gml:id="UUID_e5b1ad7a-7c42-4f20-a540-12a1f03bc610">
```

```
      <type>exterior</type>
```

```
    </Node>
```

```
  </nodeMember>
```

```
</FeatureGraph>
```

Revised components package

Three types of components

- distribution elements (e.g. pipes, canals, cables)
- protection elements (e.g. cable protection package, ductwork)
- **functional elements** (e.g. manholes, station)
→ refined to better meet the demands of various use cases

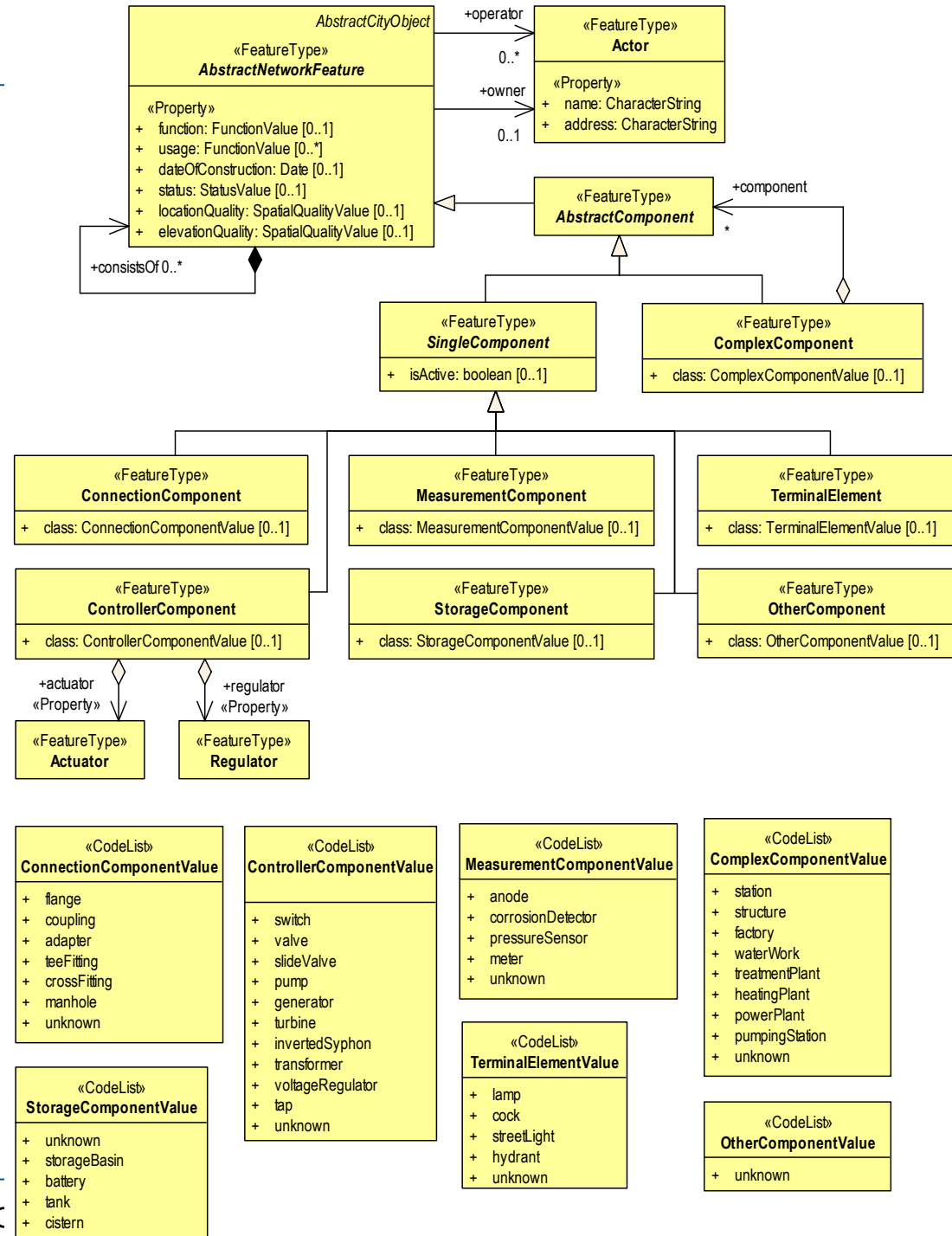

Common Information Model (CIM) (I)

Overview CIM– 1



- Model type
 - Conceptual data model represented in UML
 - An encoding of the complete model does not exist
- Application range
 - Modeling of electricity networks, including information on power system components and their relations, Energy Management Systems (EMS), Supervisory Control and Data Acquisition (SCADA) systems, planning and optimization, asset management, work schedules, payment metering, customer information systems and enterprise resource planning
- Responsible organization
 - International Electrotechnical Commission (IEC), TC57, WG14
 - IEC 61970-301 (Base package)
 - IEC 61968-11 (Extension)
 - Adopted by European und German National standards

Common Information Model (CIM) (II)

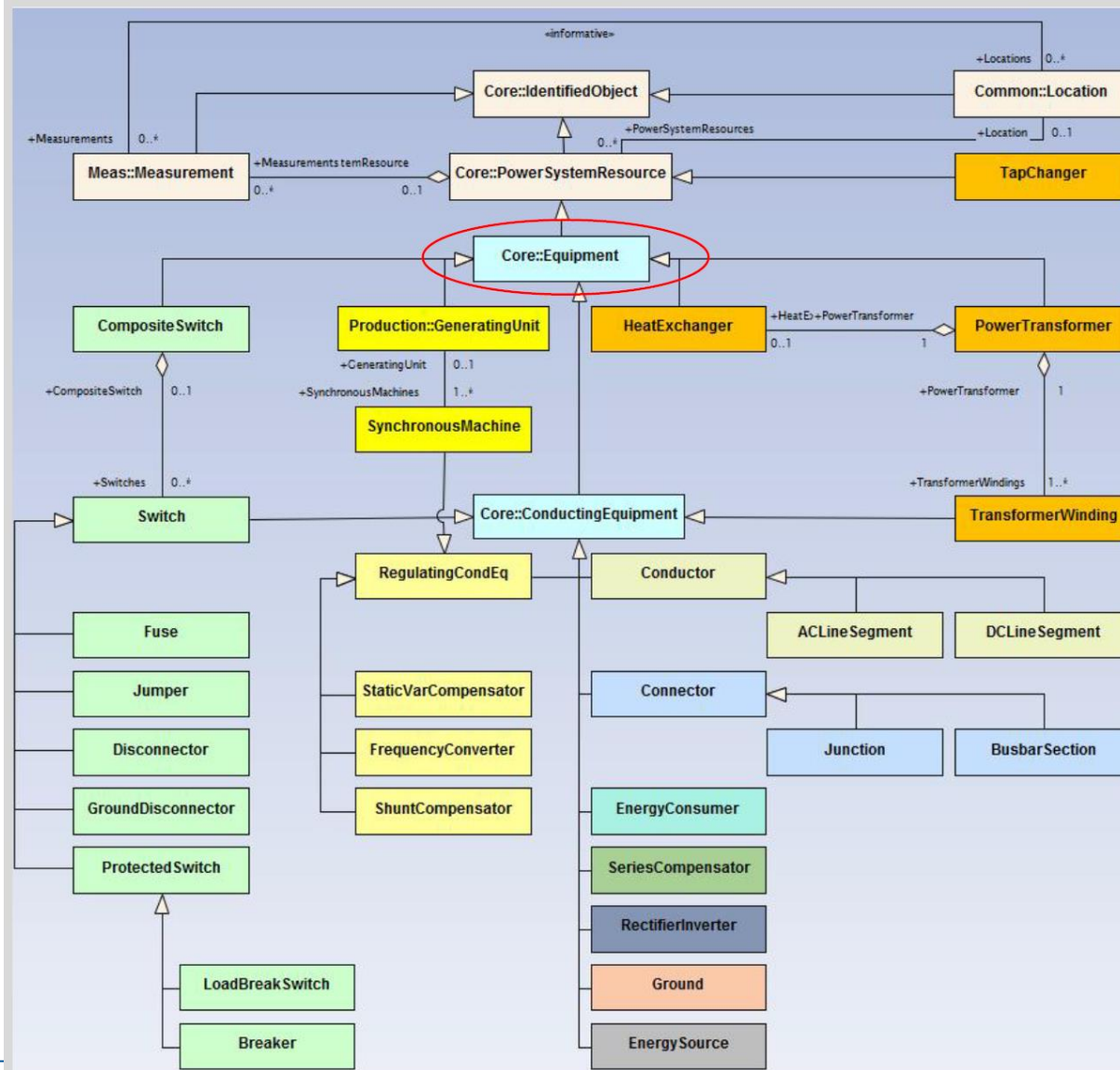

The parts of a power system that are physical devices, electronic or mechanical

Electricity Network Package

- Defines components which are specific to electricity networks
- Development is based on the CIM model

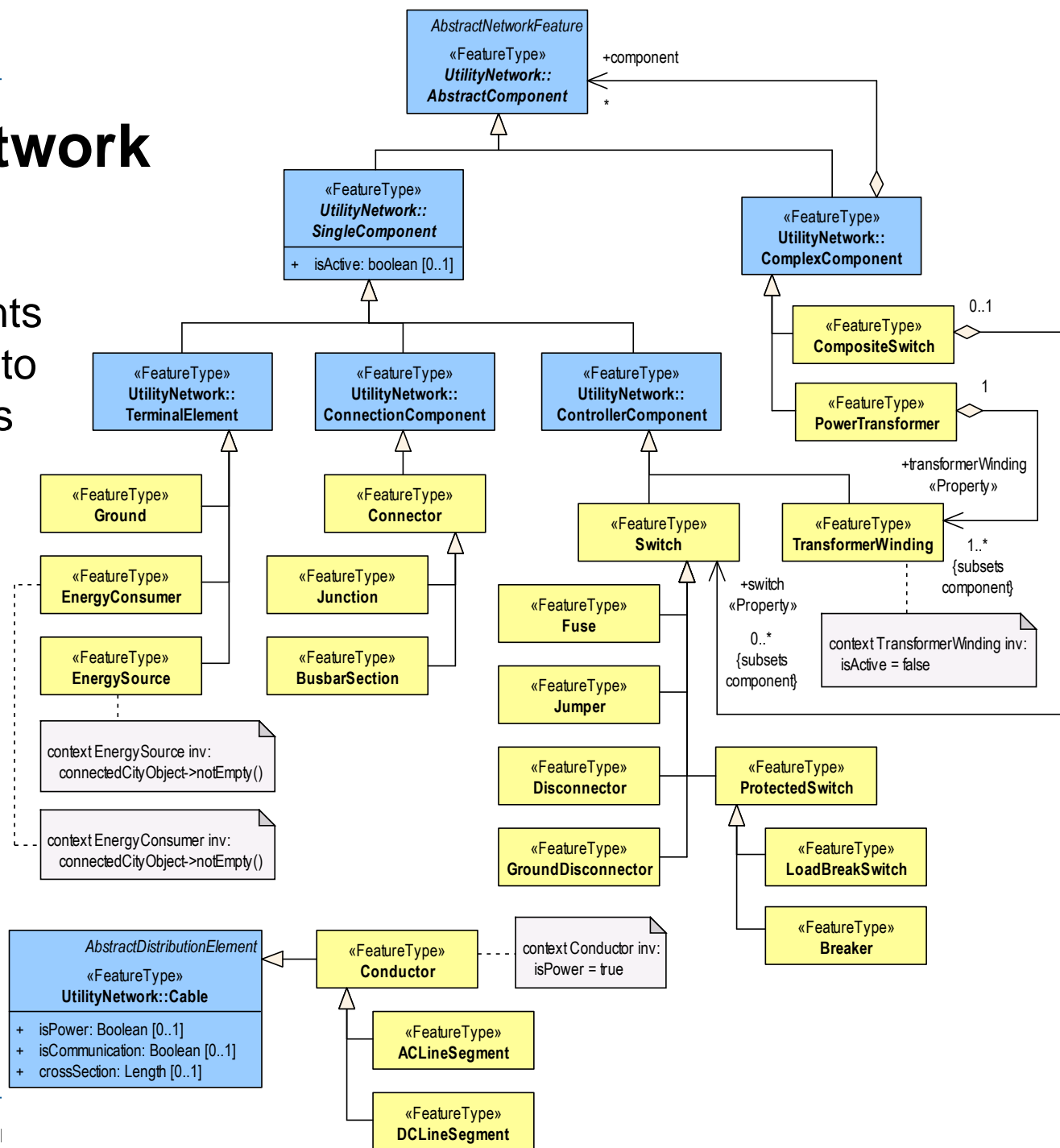

Further information on the Utility Network ADE

Publications:

- Becker, Thomas; Nagel, Claus; Kolbe, Thomas H. (2012) Semantic 3D modeling of multi-utility networks in cities for analysis and 3D visualization:
<http://mediatum.ub.tum.de/doc/1145724/287720.pdf>
- Becker, Thomas; Nagel, Claus; Kolbe, Thomas H. (2011) Integrated 3D Modeling of Multi-utility Networks and Their Interdependencies for Critical Infrastructure Analysis:
<http://mediatum.ub.tum.de/doc/1145740/358854.pdf>
- Kutzner, Tatjana; Kolbe, Thomas H. (2016) Extending Semantic 3D City Models by Supply and Disposal Networks for Analysing the Urban Supply Situation:
<https://mediatum.ub.tum.de/doc/1304227/1304227.pdf>
- Hijazi, Ihab; Kutzner, Tatjana; Kolbe, Thomas H. (2017) Use Cases and their Requirements on the Semantic Modeling of 3D Supply and Disposal Networks:
<http://mediatum.ub.tum.de/doc/1352269/192884.pdf>

Presentation at Underground CDS Workshop, New York, April 2017:

- CityGML Utility Network ADE - Scope, Concepts, and Applications:
https://portal.opengeospatial.org/files/?artifact_id=73808
- Video of Underground Utilities in Berlin:
https://portal.opengeospatial.org/files/?artifact_id=73809

Working group

- ▶ A **Joint SIG 3D and OGC Utility Network ADE working group** is further developing the ADE to make it usable for other use cases as well
 - Further information on the Utility Network ADE workshops including presentations and results is available at:
<http://en.wiki.utilitynetworks.sig3d.org/>
 - Resources (UML model, XML schema, using the ADE with FME, links to test data sets) are provided on this github repository:
<https://github.com/TatjanaKutzner/CityGML-UtilityNetwork-ADE>
 - The next joint SIG 3D and OGC workshop will take place in autumn 2018
 - If you are interested in participating in the working group, please contact Tatjana Kutzner (kutzner@tum.de)

Summary

- ▶ **Core model for the representation of arbitrary utility networks**
 - **3D topographic** modelling
 - **3D topological** and **functional** modelling
 - Support of **hierarchies**: complex objects, network hierarchies
 - Provides homogenized and integrated view on multi-utility networks
- ▶ **The core model is independent of a specific type of utility / commodity**
- ▶ **Utility-specific, concrete feature classes**
 - including characteristics, materials and functional aspects of the features
- ▶ The ADE allows for
 - **linking utility networks with 3D city models**
 - **modeling multi-utility scenarios**

→ this is not supported by other existing utility modeling standards