

# **NOTES on corrigenda**

## **Corrigendum 1.0.2**

Schema change only, the reference to ISO 19139 schema does not itself reference the current version of GML 3.2.

Change reference:

[http://standards.iso.org/ittf/PubliclyAvailableStandards/ISO\\_19139\\_Schemas/](http://standards.iso.org/ittf/PubliclyAvailableStandards/ISO_19139_Schemas/)

To:

<http://schemas.opengis.net/iso/19139/20070417>

## **Corrigendum 1.0.1**

Schema change only, the references to ISO 19139 and ISO 19119 are updated the current approved version of those standards.

# Open Geospatial Consortium

Submission Date: 2018-08-23

Approval Date: 2017-06-29

Publication Date: 2020-11-19

External identifier of this OGC® document: <<http://www.opengis.net/doc/IS/cat2.0.2-isometadata/1.0.2>>

Internal reference number of this OGC® document: 07-045r2

Version: 1.0.2

Category: OGC® Implementation standard application profile

Editor: Uwe Voges, Kristian Senkler

## OpenGIS® Catalogue Services Specification 2.0.2 - ISO Metadata Application Profile: Corrigendum

### Copyright notice

Copyright © 2020 Open Geospatial Consortium

To obtain additional rights of use, visit <http://www.opengeospatial.org/legal/>.

### Warning

This document is an OGC Member endorsed international Community standard. This Community standard was developed outside of the OGC and the originating party may continue to update their work; however, this document is fixed in content. This document is available on a royalty free, non-discriminatory basis. Recipients of this document are invited to submit, with their comments, notification of any relevant patent rights of which they are aware and to provide supporting documentation.

Document type: OGC® Standard  
Document subtype: Application Profile  
Document stage: Approved  
Document language: English

## License Agreement

Permission is hereby granted by the Open Geospatial Consortium, ("Licensor"), free of charge and subject to the terms set forth below, to any person obtaining a copy of this Intellectual Property and any associated documentation, to deal in the Intellectual Property without restriction (except as set forth below), including without limitation the rights to implement, use, copy, modify, merge, publish, distribute, and/or sublicense copies of the Intellectual Property, and to permit persons to whom the Intellectual Property is furnished to do so, provided that all copyright notices on the intellectual property are retained intact and that each person to whom the Intellectual Property is furnished agrees to the terms of this Agreement.

If you modify the Intellectual Property, all copies of the modified Intellectual Property must include, in addition to the above copyright notice, a notice that the Intellectual Property includes modifications that have not been approved or adopted by LICENSOR.

THIS LICENSE IS A COPYRIGHT LICENSE ONLY, AND DOES NOT CONVEY ANY RIGHTS UNDER ANY PATENTS THAT MAY BE IN FORCE ANYWHERE IN THE WORLD.

THE INTELLECTUAL PROPERTY IS PROVIDED "AS IS", WITHOUT WARRANTY OF ANY KIND, EXPRESS OR IMPLIED, INCLUDING BUT NOT LIMITED TO THE WARRANTIES OF MERCHANTABILITY, FITNESS FOR A PARTICULAR PURPOSE, AND NON-INFRINGEMENT OF THIRD PARTY RIGHTS. THE COPYRIGHT HOLDER OR HOLDERS INCLUDED IN THIS NOTICE DO NOT WARRANT THAT THE FUNCTIONS CONTAINED IN THE INTELLECTUAL PROPERTY WILL MEET YOUR REQUIREMENTS OR THAT THE OPERATION OF THE INTELLECTUAL PROPERTY WILL BE UNINTERRUPTED OR ERROR FREE. ANY USE OF THE INTELLECTUAL PROPERTY SHALL BE MADE ENTIRELY AT THE USER'S OWN RISK. IN NO EVENT SHALL THE COPYRIGHT HOLDER OR ANY CONTRIBUTOR OF INTELLECTUAL PROPERTY RIGHTS TO THE INTELLECTUAL PROPERTY BE LIABLE FOR ANY CLAIM, OR ANY DIRECT, SPECIAL, INDIRECT OR CONSEQUENTIAL DAMAGES, OR ANY DAMAGES WHATSOEVER RESULTING FROM ANY ALLEGED INFRINGEMENT OR ANY LOSS OF USE, DATA OR PROFITS, WHETHER IN AN ACTION OF CONTRACT, NEGLIGENCE OR UNDER ANY OTHER LEGAL THEORY, ARISING OUT OF OR IN CONNECTION WITH THE IMPLEMENTATION, USE, COMMERCIALIZATION OR PERFORMANCE OF THIS INTELLECTUAL PROPERTY.

This license is effective until terminated. You may terminate it at any time by destroying the Intellectual Property together with all copies in any form. The license will also terminate if you fail to comply with any term or condition of this Agreement. Except as provided in the following sentence, no such termination of this license shall require the termination of any third party end-user sublicense to the Intellectual Property which is in force as of the date of notice of such termination. In addition, should the Intellectual Property, or the operation of the Intellectual Property, infringe, or in LICENSOR's sole opinion be likely to infringe, any patent, copyright, trademark or other right of a third party, you agree that LICENSOR, in its sole discretion, may terminate this license without any compensation or liability to you, your licensees or any other party. You agree upon termination of any kind to destroy or cause to be destroyed the Intellectual Property together with all copies in any form, whether held by you or by any third party.

Except as contained in this notice, the name of LICENSOR or of any other holder of a copyright in all or part of the Intellectual Property shall not be used in advertising or otherwise to promote the sale, use or other dealings in this Intellectual Property without prior written authorization of LICENSOR or such copyright holder. LICENSOR is and shall at all times be the sole entity that may authorize you or any third party to use certification marks, trademarks or other special designations to indicate compliance with any LICENSOR standards or specifications. This Agreement is governed by the laws of the Commonwealth of Massachusetts. The application to this Agreement of the United Nations Convention on Contracts for the International Sale of Goods is hereby expressly excluded. In the event any provision of this Agreement shall be deemed unenforceable, void or invalid, such provision shall be modified so as to make it valid and enforceable, and as so modified the entire Agreement shall remain in full force and effect. No decision, action or inaction by LICENSOR shall be construed to be a waiver of any rights or remedies available to it.

## Contents

|          |   |           |
|----------|---|-----------|
| <b>1</b> | <b>SCOPE</b> .....  | <b>23</b> |
| <b>2</b> | <b>CONFORMANCE</b> .....  | <b>23</b> |
| <b>3</b> | <b>NORMATIVE REFERENCES</b> .....                                   | <b>23</b> |
| <b>4</b> | <b>TERMS AND DEFINITIONS</b> .....                                  | <b>25</b> |
| <b>5</b> | <b>CONVENTIONS</b> .....  | <b>28</b> |
| 5.1      | SYMBOLS (AND ABBREVIATED TERMS) .....                               | 28        |
| 5.2      | UML NOTATION .....  | 30        |
| 5.3      | DOCUMENT TERMS AND DEFINITIONS.....                                 | 31        |
| <b>6</b> | <b>SYSTEM CONTEXT</b> .....   | <b>31</b> |
| 6.1      | APPLICATION DOMAIN.....   | 31        |
| 6.2      | ESSENTIAL USE CASES .....   | 32        |
| 6.2.1    | <i>Publish metadata</i> .....                                       | 33        |
| 6.2.2    | <i>Discover metadata</i> .....                                      | 34        |
| 6.2.3    | <i>Harvest metadata</i> .....                                       | 34        |
| <b>7</b> | <b>INFORMATION MODELS</b> .....                                     | <b>35</b> |
| 7.1      | CAPABILITY CLASSES .....  | 35        |
| 7.2      | CATALOGUE INFORMATION MODEL.....                                    | 36        |
| 7.2.1    | <i>Information Resources</i> .....                                  | 38        |
| 7.2.1.1  | Datasets and datasetcollections.....                                | 39        |
| 7.2.1.2  | Service (loosely-/tightly-/mixed-coupled).....                      | 39        |
| 7.2.1.3  | Applications.....   | 40        |
| 7.2.2    | <i>Extensions</i> .....   | 40        |
| 7.2.2.1  | Extensions to ISO 19115:2003/Cor.1:2006.....                        | 40        |
| 7.2.2.2  | Extensions to 19119:2005/PDAM 1 .....                               | 41        |
| 7.2.3    | <i>Mappings to the common XML Record format</i> .....               | 42        |
| 7.2.3.1  | Core queryable properties.....                                      | 42        |
| 7.2.3.2  | Core returnable properties .....                                    | 46        |
| 7.2.4    | <i>Additional search properties</i> .....                           | 47        |
| 7.2.5    | <i>Additional returnable properties</i> .....                       | 52        |
| 7.3      | SUPPORTED DATA BINDINGS.....  | 54        |
| 7.3.1    | <i>Dataset</i> .....  | 55        |
| 7.3.2    | <i>Datasetcollection</i> .....                                      | 55        |
| 7.3.3    | <i>Service</i> .....  | 55        |
| 7.3.4    | <i>Application</i> .....  | 55        |
| 7.4      | RESULT SETS .....   | 56        |
| 7.4.1    | <i>BRIEF Resultset</i> .....  | 57        |
| 7.4.2    | <i>SUMMARY Resultset</i> .....                                      | 57        |
| 7.4.3    | <i>FULL Resultset</i> .....   | 58        |
| 7.5      | SERVICE INFORMATION MODEL .....                                     | 58        |
| 7.6      | COLLABORATION WITH CATALOGS BASED ON OTHER CSW 2.0.2 PROFILES ..... | 60        |
| 7.7      | NATIVE LANGUAGE SUPPORT .....                                       | 61        |
| <b>8</b> | <b>EXTERNAL INTERFACES</b> .....                                    | <b>61</b> |
| 8.1      | IMPORTED PROTOCOL BINDING (RELATIONSHIP TO THE COMMON MODEL).....   | 62        |
| 8.2      | INTERFACE SPECIFICATIONS .....                                      | 63        |
| 8.2.1    | <i>OGC Service Interface</i> .....                                  | 63        |
| 8.2.1.1  | GetCapabilities Operation.....                                      | 63        |

|           |  |    |
|-----------|--|----|
| 8.2.2     | <i>CSW Discovery Interface</i> .....                             | 66 |
| 8.2.2.1   | GetRecords Operation.....  | 66 |
| 8.2.2.1.1 | Request.....   | 66 |
| 8.2.2.1.2 | Response .....   | 72 |
| 8.2.2.2   | GetRecordById Operation .....                                    | 74 |
| 8.2.2.2.1 | Request.....   | 74 |
| 8.2.2.2.2 | Response .....   | 75 |
| 8.2.2.3   | DescribeRecord Operation.....                                    | 76 |
| 8.2.2.3.1 | Request.....   | 76 |
| 8.2.2.3.2 | Response .....   | 77 |
| 8.2.2.4   | GetDomain Operation.....   | 78 |
| 8.2.2.4.1 | Request.....   | 78 |
| 8.2.2.4.2 | Response .....   | 79 |
| 8.2.3     | <i>CSWT Manager Interface</i> .....                              | 80 |
| 8.2.3.1   | Transaction Operation.....                                       | 80 |
| 8.2.3.1.1 | Request.....   | 80 |
| 8.2.3.1.2 | Response .....   | 85 |
| 8.2.3.2   | Harvest Operation .....  | 85 |
| 8.2.3.2.1 | Request.....   | 86 |
|           | An example for the Harvest request is described in Annex G. .... | 88 |
| 8.2.3.2.2 | Response .....   | 88 |
| 8.2.3.3   | Record locking.....  | 89 |
| 8.2.4     | <i>Error handling</i> .....                                      | 89 |
| 8.3       | QUERY FACILITIES.....  | 90 |
| 8.4       | IMPLEMENTATION GUIDANCE.....                                     | 91 |
| 8.4.1     | <i>Technical issues</i> .....                                    | 91 |
| 8.4.2     | <i>Semantic issues</i> .....                                     | 91 |
| 8.4.3     | <i>Metadata set examples</i> .....                               | 92 |
| 8.5       | SECURITY CONSIDERATIONS.....                                     | 92 |

## Figures

|   |     |
|---|-----|
| Figure 1 UML notations.....   | 30  |
| Figure 2: Overall system use cases .....  | 32  |
| Figure 3: Publish metadata.....   | 33  |
| Figure 4: Discover metadata .....   | 34  |
| Figure 5: Harvest metadata .....  | 34  |
| Figure 6: CSW capability classes .....  | 36  |
| Figure 7: Basic classes - Excerpt from 19115:2003/Cor.1:2006 .....  | 37  |
| Figure 8: Extension to class <<SV_CoupledResource>>.....  | 42  |
| Figure 9: Distributed Search on other base- or profile- CSW 2.0.2 catalogs .....  | 61  |
| Figure 10: Schematic profile dependant getRecords call (profile determined by handshake).....   | 65  |
| Figure 11 - XML Packaging .....   | 100 |
| Figure 12 - Organization of the srv namespace .....   | 100 |
| Figure 13 - SV_Parameter and SV_OperationMetadata data types implemented in XML Schema.....   | 102 |
| Figure 14 - SV_Interface, SV_PortSpecification and SV_Port data types implemented in XML Schema.....  | 103 |
| Figure 15 - SV_ServiceSpecification, SV_PlatformNeutralServiceSpecification and SV_PlatformSpecificServiceSpecification data types implemented in XML Schemas ..... | 104 |
| Figure 16 - Modification of the modeling of abstract to implementation service specifications .....   | 105 |
| Figure 17: Search for WCS tightly-coupled with “landcoverage” datasets (schematic)  | 119 |

## Tables

|   |    |
|---|----|
| Table 1 - Operations provided by CSW capability classes.....                              | 35 |
| Table 2 - Class descriptions .....  | 37 |
| Table 3: Information resources .....  | 38 |
| Table 4 - Data dictionary for MD_ScopeCode <<CodeList>> .....                             | 41 |
| Table 5 — Data dictionary for SV_CoupledResource .....                                    | 42 |
| Table 6 – Mapping to common queryable elements.....                                       | 43 |
| Table 7 - Composition of compound element “BoundingBox”.....                              | 45 |
| Table 8 - Composition of compound element “CRS” .....                                     | 45 |
| Table 9 - Mapping to common returnable properties .....                                   | 46 |
| Table 10 - Additional queryable properties common to all information resources .....      | 48 |
| Table 11 - Additional queryable properties (dataset, datasetcollection, application)..... | 49 |
| Table 12 - Composition of union SpatialResolution.....                                    | 50 |
| Table 13:Composition of union TemporalExtent .....  | 50 |
| Table 14 - Additional queryable properties (service) .....                                | 51 |
| Table 15:Composition of union OperatesOnData.....   | 51 |
| Table 16: Additional returnable properties common to all types of resources .....         | 52 |
| Table 17: Additional returnable properties for dataset .....                              | 53 |
| Table 18: Additional returnable properties for service .....                              | 53 |
| Table 19 - Composition of union SpatialResolution.....                                    | 53 |
| Table 20: Composition of union ReferenceSystem .....                                      | 54 |
| Table 21: Composition of union ServiceOperation .....                                     | 54 |
| Table 22 - Overview AP ISO resultsets .....   | 56 |
| Table 23 – Additional GetRecords constraints .....  | 59 |
| Table 24 – Additional operation constraints .....   | 59 |
| Table 25 - Mapping CSW(T) ISO operations to CSW operations .....                          | 62 |
| Table 26 - Operation request encoding .....   | 63 |
| Table 27 – Some Parameters in GetCapabilities operation request .....                     | 64 |
| Table 28 – Permissible section names .....  | 65 |
| Table 29 - Parameters in GetRecords operation request.....                                | 67 |

**OGC 07-045r2**

|  |    |
|--|----|
| Table 30 - Parameters in GetRecordById operation request .....   | 74 |
| Table 31 - Parameters in DescribeRecord operation request.....   | 76 |
| Table 32 - Parameters in GetDomain operation request.....        | 78 |
| Table 33 - Parameters in Transaction operation request.....      | 80 |
| Table 34 - Parameters of Insert-, Update-, Delete-Operation..... | 81 |
| Table 35 - Parameters of Insert-Operation.....                   | 81 |
| Table 36 - Parameters of Update-Operation .....                  | 82 |
| Table 37 - Parameters of Delete-Operation .....                  | 84 |
| Table 38 - Parameters in Harvest operation request .....         | 86 |
| Table 39 - Exception codes and meanings (from OGC Common).....   | 89 |



**Listings**

Listing 1 - OGC\_Service: WSDL interface definition ..... 66

Listing 2 - SearchResultType definition ..... 73

Listing 3 - GetRecordByIdResponseType definition ..... 75

Listing 4 - TransactionResponse definition ..... 85

Listing 5 - HarvestResponse definition..... 88

## **i. Preface**

This document explains how Catalogue Services based on the ISO19115/ISO19119 Application Profile for the OGC® Catalogue Services Specification v 2.0.2 [OGC 07-006] are organized and implemented for the discovery, retrieval and management of data metadata, services metadata and application metadata.

## **ii. Submitting organizations**

The following organizations submitted the original document or its revisions to the Open Geospatial Consortium, Inc. in response to the OpenGIS Web Service Testbed 2 (OWS2), the OGC® Catalogue Services Specification 2.0 Revision Working Group and the OpenGIS® Catalogue Services Specification 2.0.2 ISO Metadata Application Profile Revision Working Group.

**con terra** Gesellschaft für Angewandte Informationstechnologie mbH

**lat/ion** Gesellschaft für raumbezogene Informationssysteme mbH

### **Contributing Entities**

The submitting entities were grateful for the contributions from the following companies in the development and revision of this Interface Specification:

Arbeitsgemeinschaft der Vermessungsverwaltungen der Länder (AdV), Germany

BAE Systems

Bundesamt für Kartographie und Geodäsie (BKG), Germany

CeGi - Center for Geoinformation GmbH, Germany

con terra GmbH, Germany

Crisalis Technologies, Italy

Delphi MM GmbH, Germany

disy GmbH, Germany

ESRI, USA

ESRI Netherlands B.V., Netherlands

European Space Agency (ESA)  
Food and Agriculture Organization of the United Nations (FAO) in Italy  
Federal Geographic Data Committee (FGDC), USA  
Galdos Systems Inc., Canada  
Geodateninfrastruktur SIG Brandenburg, Germany  
Geodateninfrastruktur SIG Nordrhein-Westfalen (GDI NRW) , Germany  
Geoforschungszentrum Potsdam, Germany  
Geoscience, Australia  
Geotask AG, Switzerland  
Help Service Remote Sensing s.r.o., Czech Republic  
Hessisches Ministerium für Umwelt, ländlichen Raum und Verbraucherschutz,  
Germany  
InGeoForum, Germany  
Innenministerium Nordrhein-Westfalen, Germany  
Institut Cartogràfic de Catalunya, Spain  
Institut Geographique National (IGN) (France)  
Institut für Geoinformatik, Universität Münster, Germany  
Intergraph Corporation, USA  
Joint Research Center (JRC), European Commission in Ispra, Italy  
Koordinierungsstelle UDK/GEIN im Niedersächsischen Umweltministerium,  
Germany  
Landesamt für Bergbau und Geologie Brandenburg (LBGR), Germany  
Landesamt für Vermessung und Geoinformation Bayern, Germany  
Landesbetrieb Geoinformation und Vermessung Hamburg, Germany  
Landesvermessung und Geobasisinformation Niedersachsen, Germany  
Landesvermessung und Geobasisinformation Brandenburg, Germany  
Landesvermessungsamt Nordrhein-Westfalen (LVermA NRW) , Germany  
lat/ion GmbH, Germany  
Magellium, France  
NASA (Computer Sciences Corp), USA

Ravi Network voor Geo-informatie, Netherlands  
 Senatsverwaltung für Stadtentwicklung Berlin, Germany  
 GIM NV, Belgium  
 Spacebel s.a., Belgium  
 Wirtschaftsministerium Hessen/AdV, Germany

### iii. Document contributor contact points

All questions regarding this document should be directed to the editor or the contributors:

| Contact                         | Company                                 | Address   |
|---------------------------------|---|---|
| Uwe Voges                       | con terra GmbH                          | Martin-Luther-King-Weg 24, 48155 Münster, Germany   |
| Kristian Senkler                | con terra GmbH                          | Martin-Luther-King-Weg 24, 48155 Münster, Germany   |
| Markus Müller /<br>Andreas Poth | lat/lon GmbH                            | Aennchenstr. 19, 53177 Bonn, Germany                |
| Jason Cupp                      | Esri Inc.                               | 380 New York Street, Redlands, CA 92373-8100, USA   |
| Nicolas Lesage                  | Institution Géographique National (IGN) | DT/TN 2/4, avenue Pasteur 94160 Saint-Mande, France |

### iv. Revision history

| Date      | Internal version | Editor        | Primary clauses modified | Description  |
|-----------|------------------|---------------|--------------------------|--|
| 28Jan2004 | 0.0              | Voges         | N/A                      | Initialized Document   |
| 10Feb2004 | 0.1              | Voges         | N/A                      | Included first decisions from the “Arbeitskreis Metainformationssysteme” |
| 22Mar2004 | 0.2              | Voges/Senkler |                          | Definition of information model, queryable attributes, result sets,...   |

| <b>Date</b> | <b>Internal version</b> | <b>Editor</b> | <b>Primary clauses modified</b>                           | <b>Description</b>   |
|-------------|-------------------------|---------------|---|--|
| 22Mar2004   | 0.2                     | Senkler       | 3 Normative references<br>7.2.1.2 Service Instance        | Some general modifications   |
| 31Mar2004   | 0.3                     | Voges/Senkler | All   | Inserted decision from the WG Metainformation. Added section 8.1, Added Operations to External Interfaces  |
| 07Apr2004   | 0.3                     | Senkler       | 6.2   | Added first version of use cases. To be refined....  |
| 16Apr2004   | 0.3                     | Senkler       | 7.x Information model                                     | Added Information model  |
| 20Apr2004   | 0.3                     | Senkler/Voges | N/A   | Revision in several places   |
| 26Apr2004   | 0.3                     | Senkler       | 7.2.1/7.2.2   | Integration of information model and CSW extensions  |
| 28Apr2004   | 0.3                     | Voges         | 8.1/8.2   | Adoption to actual OWS Common and CSW 2.0 specification  |
| 10May2004   | 0.3                     | Voges         | 7.2.3, 8.3  | Core queryables: Association attribute defined, additional search properties defined   |
| 12May2004   | 0.3                     | Senkler       | Preface, 6.2, 7.2.x, 7.3, 7.4, 7.5, 7.7<br>Appendix A & B | Updated some figures, added the entire information model; added Mapping to common XML record format; added supported data bindings, added result sets; added native language support, added Appendix B and A |
| 18May2004   | 0.4                     | Voges         | 7,8   | Some smaller changes in chapter 7. Revised the chapter 8 concerning final changes of the OGC CS 2.0 spec.  |
| 18May2004   | 0.5                     | Senkler       | 7.2.4 (modified)  | Added HasSecurityConstraints   |
| 24May2004   | 0.6                     | Voges         | 8.3, 8.2.2.3  | Added query facilities, DescribeRecordType defined, editorial changes  |
| 27May2004   | 0.7                     | Voges         | 7.2.3.1   | CRS in urn syntax,   |
| 04June2004  | 0.8                     | Voges         | 1, 4, 5, 7.2, 7.3   | Revised the chapters based on the review comments  |
| 05June2004  | 0.9                     | Senkler       | 2, 3, 6, 7, 8, Annexes                                    | Revised the chapters based on the review comments  |
| 14June2004  | 0.9.1                   | Voges         | 8   | Some smaller "bug-fixes"   |
| 12July2004  | 0.9.2                   | Senkler       | 8.2.1.1, Table 8  | "Upper-cased" Request parameters, corrected mapping to dc:language   |

| Date      | Internal version | Editor                 | Primary clauses modified | Description   |
|-----------|------------------|------------------------|--------------------------|---|
| 22Dec2004 | 0.9.3            | Voges                  | 7.3.3, 7.4, 8.4          | xml schemas updated, implementation guidance, editorial changes.  |
| 14Mar2005 | 0.9.4            | Voges                  | 7.4, 8.2.2.1, 8.4.2      | Changed "profile" to "ISOPROFILE"...  |
| 27Sep2005 | 0.9.5            | Voges                  | several                  | <p>I. OGC CS 2.0.1 Corrigendum: Adaptations to Annex E of CS 2.0.1 with Corrigendum. This includes: update of xml schemas (also the xml schema snippets in the document) and update of the xml examples.</p> <p>II. Adaptations to a few change requests coming from the german metadata working group "AK Metadaten": a extension of summary resultset, addition of fileIdentifier as search attribute, more precise definition of the protocol bindings, especially the SOAP binding (added WSDL description), redefinition of the semantic of the search attribute CRS, defined the query facilities (8.3) more precisely</p> <p>III. Other: actualization of the service metadata example, addition of a dataset metadata example, corrections, coming from Intergraph, editorial changes (format, ogc headers, ...), update of Contributing Entities, actualization of document references, added symbols and UML notation</p> |
| 18Nov2005 | 0.9.6            | Senkler                | Table 6 & 9              | Update mapping for CRS  |
| 15Dec2005 | 0.9.6            | Voges                  | 7.2.3, 7.2.4, 7.3        | Revised chapter 7.3, revised mappings of the querables and the returnables  |
| 13Jan2006 | 0.9.6            | Voges                  | 7.2.3, 7.2.4             | Include error corrections coming from Crisalis Tech.  |
| 16Feb2006 | 0.9.6            | Müller; Senkler, Voges | 7.2.2                    | - Addition of some clarifications concerning tightly coupled services and the search possibilities on it  |
| 22Feb2006 | 1.0              | Voges                  | 7.2, 7.3, 8              | ISO/TS 19139 (10/2005) Update: XPath mappings of all queryable and returnable properties in the document, mappings of the derivation of the resource type (e.g. dataset) definitions. Corrections of some errors in the interface specifications. Extensions to implementation guidelines. Editorial Changes.   |
| 10Mar2006 | 1.0              | Voges                  |                          | Corrected some errors mentioned by Ravi (NL), added section on collaboration with other CSW 2.0 (profile) catalogs.   |

| Date      | Internal version | Editor    | Primary clauses modified | Description   |
|-----------|------------------|-----------|--------------------------|---|
| 21Mar2006 | 1.0              | Senkler   |                          | <ul style="list-style-type: none"> <li>- Added schemas to Annex D</li> <li>- Changed IsoProfile to IsoRecord</li> <li>- Added some refinements on mapping of queryables</li> <li>- Added clauses on &lt;xsd:any&gt; substitution</li> <li>- Rephrased clause on ISO 19119 with text form ISO 19119 / PDAM 1</li> <li>- Added extension to MD_ScopeCode for resource type 'application'</li> </ul>   |
| 4Apr2006  | 1.0              | Carl Reed |                          | <ul style="list-style-type: none"> <li>- Copyright, fix title, cover page changes.</li> </ul>   |
| 10Aug2006 | 1.0              | Voges     | 7.2.3, 7.5               | <ul style="list-style-type: none"> <li>- Corrected Xpaths</li> <li>- Created a xml-schema for the CSW-ISO capabilities documents and added additional service metadata elements</li> </ul>  |
| 29Sep2006 | 1.0              | Voges     | several                  | <p>Included solved solutions for all RFC comments except # 1,3, 8, 42, 44, 45, 47.</p> <p>New:</p> <ul style="list-style-type: none"> <li>#7: unreproducible</li> <li>#33: graphicOverview in brief result corrected</li> <li>#34: Summary xml schema corrected: referenceSystemInfo goes now after identificationInfo</li> <li>distributionInfo goes now before dataQuality</li> <li>federatedCatalogue included</li> <li>#36: error in base spec</li> <li>#37: corrected</li> <li>#38: included</li> <li>#39: explained</li> <li>#40: explained, may be to have discussed. If further DC elements should be queryable this requires a change in the base spec to specify additional queryable in the capabilities document)</li> <li>#41: Corrected filter example</li> <li>#42: outputSchema - under discussion</li> <li>#43: Corrected as far as possible</li> </ul> <p>The most comments are now corrected, explained (some also rejected)</p> |

| Date      | Internal version | Editor                                   | Primary clauses modified | Description   |
|-----------|------------------|--|--------------------------|---|
| 20Nov2006 | 1.0              | Senkler, Lesage, Voges, Westcott, Martin | several                  | <p>Inserted figure on distributed search, inserted outputSchema for KVP based getRecordById, added description for capabilities based “handshake”, #1: WSDL file (we are currently fixing this #3: ISO19139 can now be handled #8: solved #35: some examples added #42: solved (clarified) #45: The XSD schema for brief and summary will no longer be supported. Instead, the only valid schema is ISO 19139 as referenced in the normative reference section. For brief and summary responses, a section was be put in the document that defines the elements that should be (at a minimum) in a brief and in a summary response respectively. The advantage of that approach is obvious: we have only to handle and maintain one schema and the brief/summary results sets might have more elements than defined and remain valid with the schema. So user communities can “extend” these resultsets but will at the same time remain compliant with the application profile #46: A new schema for services was derived directly from the UML and included in Annex D. Basis here is ISO 19119 PDAM 1. The targetNamespace for this schema will be defined as ‘http://www.isotc211.org/2005/srv’ Added sequence diagrams for search for tightly-coupled service and for capabilities "handshake"</p> |
| 08Jan2007 | 1.0              | Senkler                                  | 7.3                      | <ul style="list-style-type: none"> <li>- Corrected xPath of hierarchyLevel attribute</li> <li>- fileIdentifier is no longer mandatory.</li> <li>- same is true for hierarchyLevel: if missing, default is now “dataset”. This is in line with ISO 19115.</li> </ul>   |
| 06Feb2007 | 1.0              | Voges                                    | several                  | - Synchronized the document with CSW 2.0.2 base specification   |
| 05Mar2007 | 1.0              | Senkler                                  | Whole document           | Corrected formatting  |
|           |                  |  | Whole document           | Important information now starts with the “NOTE” keyword  |
|           |                  |  | 7.2.3                    | Rechecked the mapping and XPath expressions against CSW 2.0.2 and ISO 19139 (both queryables and returnables)   |
|           |                  |  | 7.2.3.1                  | Added table 7: “Composition of compound element “CRS”   |
|           |                  |  | 7.2.3.2                  | Added TemporalExtent  |
|           |                  |  | 7.2.3.2                  | Added table 12: “Composition of union TemporalExtent”   |



| Date      | Internal version | Editor                                  | Primary clauses modified | Description   |
|-----------|------------------|---|--------------------------|---|
|           |                  |   | 7.2.3.2                  | Added OperatesOnData in table 13  |
|           |                  |   | 7.2.3.2                  | Added Table 14: "Composition of union OperatesOnData"   |
|           |                  |   | 7.2.5                    | Added ResourceIdentifier  |
|           |                  |   | 7.4                      | Rechecked the elements of the result sets   |
|           |                  |   | 7.7                      | Added new clause on native language support   |
|           |                  |   | Annex D                  | Added service example   |
|           |                  |   | Annex F                  | Added new Annex F for examples on dataset service coupling  |
|           |                  |   | Annex G                  | Added new Annex G for general examples for request/responses  |
| 09Mar2007 | 1.0              | Voges                                   |                          |   |
|           |                  |   | 7.2.4                    | editorial, clarifications   |
|           |                  |   | 7.4                      | Table 21 outputSchemas + descriptions/clarifications  |
|           |                  |   | 7.5                      | operation constraints, added SOAP/POST encoding clarification   |
|           |                  |   | 8.2.2.3                  | DescribeRecord returns serviceMetadata.xsd instead srv.xsd  |
|           |                  |   | 8.2.1.1                  | Handshake new, WSDL interface   |
|           |                  |   | 8.2.2.3                  | DescribeRecord redefined  |
|           |                  |   | 8.3                      | Query facilities: actualized  |
|           |                  |   | Annex D                  | New ServiceInstance Example   |
|           |                  |   | Annex E                  | New Capabilities document   |
|           |                  |   | Annex G                  | Corrected example requests/responses  |
|           |                  |   | all                      | Included editorial comments from GIM NV   |
| 16Apr2007 | 1.0              | Voges/Senkler/Poth/Müller/Cupp/Westcott |                          |   |
|           |                  |   | 7.4.1                    | Brief-record redefined  |
|           |                  |   | all                      | Declared AP ISO queryables in a different namespace<br>Different editorial corrections / clarification                  |
|           |                  |   | Table 2                  | corrected   |
|           |                  |   | 7.2.2.2                  | Added definition for extension to ISO 19119:2005/PDAM1: SV CoupledResource, with UML class diagram and data dictionary. |
|           |                  |   | Annex D2                 | Added ISO 19119:2005/PDAM1 extended XML schema  |

| Date      | Internal version | Editor                         | Primary clauses modified           | Description   |
|-----------|------------------|--------------------------------|------------------------------------|---|
|           |                  |                                | all                                | editorial   |
| 20Apr2007 | 1.0              | Senkler/Voges                  |                                    | <b>The following changes were made after version 1.0 (document which was voted upon by RWG). These affect only editorial things or things which were missing before.</b>  |
|           |                  |                                | xml schemas                        | added information where to find WSDL  |
|           |                  |                                |                                    | Removed redundant property 'hierarchyLevel', as this is defined by the 'type' property of the base spec   |
|           |                  |                                |                                    | Renamed ServiceCoupling to CouplingType   |
|           |                  |                                | table 16,<br>table 17,<br>table 21 | MD_Metadata.dataQuality.DQ_DataQuality.lineage.LI_Lineage.statement<br>corrected to :<br>MD_Metadata.dataQualityInfo.DQ_DataQuality.lineage.LI_Lineage.statement<br>'spatialRepresentationTypeCode' replaced by 'spatialRepresentationType'<br>'containsOperation' replaced by 'containsOperations' |
| 30Apr2007 | 1.0              | Senkler                        | All                                | Moved the NOTE sections to normal text  |
|           |                  |                                |                                    | Worked on the references in the text  |
|           |                  |                                |                                    | General syntax check.   |
| 26Jun2007 | 1.0              | Voges                          |                                    |   |
|           |                  |                                | Table 6                            | Added "MD_Metadata.identificationInfo.MD_DataIdentification.topicCategory" to the mapping of the core queryable/returnable subject  |
|           |                  |                                | Table 9                            | Mapping of the core returnable "relation" to MD_Metadata.identificationInfo.AbstractMD_Identification.aggregationInfo   |
| 07Jul2007 | 1.0              | Voges                          |                                    |   |
|           |                  |                                | Table 11                           | TemporalExtent: Table 13 reference  |
|           |                  |                                | All                                | Editorial   |
| 13Jul2007 | 1.0              | Senkler                        | Table 14                           | Added 'GeographicDescriptionCode' with appropriate mapping.   |
| 19Jul2007 | 1.0              | Voges                          |                                    | Editorial: cover page, page headers and footers, page breaks...   |
| 1Jul2017  | 1.0.1            | Michael Lutz,<br>Scott Simmons | All                                | Prepare Corrigendum   |
| 19Nov2020 | 1.0.2            | OGC Staff                      | Schema                             | Change reference in schema  |

## v. Changes to the OGC® Abstract Specification

According to the application profile the OpenGIS® Abstract Specification requires no further changes that go beyond any changes stated in the OpenGIS® OGC™ Catalogue Services Specification v2.0.2 [OGC 07-006].

## vi. Future work

This profile specification will be adapted towards any changes resulting from further developments of the OGC® Catalogue Services Specification (and other related OGC™ Service Specifications) and the ISO 19115/19139/19119 specification process.

## vii. Foreword

This document, through its implementation profile, references several external standards and specifications as dependencies:

1. ISO/IEC TR 10000-1:1998. *Information Technology – Framework and taxonomy of International Standardised Profiles – Part 1: General principles and documentation framework*. Technical Report, JTC 1. Fourth edition. Available [online]: [http://www.iso.ch/iso/en/ittf/PubliclyAvailableStandards/c030726\\_ISO\\_IEC\\_TR\\_10000-1\\_1998\(E\).zip](http://www.iso.ch/iso/en/ittf/PubliclyAvailableStandards/c030726_ISO_IEC_TR_10000-1_1998(E).zip).
2. ISO/IEC 10746-2:1996. *Information Technology – Open Distributed Processing – Reference Model: Foundations*. Common text with ITU-T Recommendation X.902. Available [online]: [http://www.iso.ch/iso/en/ittf/PubliclyAvailableStandards/s018836\\_ISO\\_IEC\\_10746\\_2\\_1996\(E\).zip](http://www.iso.ch/iso/en/ittf/PubliclyAvailableStandards/s018836_ISO_IEC_10746_2_1996(E).zip).
3. Unified Modeling Language (UML) Version 1.3, The Object Management Group (OMG): <http://www.omg.org/cgi-bin/doc?formal/00-03-01>
4. The Extensible Markup Language (XML), World Wide Web Consortium, <http://www.w3.org/TR/1998/REC-xml-19980210>

Annex A, the Abstract Conformance Test Suite, is normative to this specification and shall be implemented when a computing environment requires catalogue services. All other annexes are informative and provide background information, such as terminology and alternative implementation approaches.

**OGC 07-045r2**

Attention is drawn to the possibility that some of the elements of this document may be the subject of patent rights. The Open GIS Consortium, Inc. shall not be held responsible for identifying any or all such patent rights.

## Introduction

Catalogue services are the key technology for locating, managing and maintaining distributed geo-resources (i.e. geospatial data, applications and services). With OGC catalogue services, client applications are capable of searching for geo-resources in a standardized way (i.e. through standardized interfaces and operations) and, ideally, they are based on a well-known information model, which includes spatial references and further descriptive (thematic) information that enables client applications to search for geo-resources in very efficient ways.

Whereas interfaces and operations of OGC catalogue services are well defined, it is left up to the developer of the system to define a specific information model which a catalogue service instance provides. This includes, but is not limited to, the information which can be inserted in the catalog, supported query languages, available search terms, response/result sets, etc. This point is of major importance with respect to interoperability between different catalogue service instances.

In Europe, running catalogue instances result from work being done within different SDI initiatives (e.g. SDI NRW Initiative<sup>1</sup>, Germany/Netherlands cross-border initiative, JRC EU Portal, EUROSTAT, Inspire, German SDI initiative). Members of these initiatives have developed an ISO-based application profile for ISO19115 metadata for geodata/geospatial applications and ISO19119-based metadata for tightly and loosely-coupled geospatial services. The foundations of this profile were the OGC catalogue specification (1.1.1), the OGC Web Registry Server (WRS) 0.0.2, OGC Web Services Stateless Catalogue Profile (StCS) 0.0.6 and ISO 19115/19119 for content description.

OGC's catalogue revision working group (CS-RWG) has revised and integrated the catalogue implementation specification v1.1.1 that have resulted in CS 2.0.2. One part of this OGC specification comprises the definition of application profiles according to ISO 19106 (*Geographic information – Profiles*). The overall goal of these profiles is to improve interoperability between systems conforming to a specific profile. Experience has shown that the need for application profiles results from the fact that in practice, there is no single solution for catalogue services that fits every user's needs. As stated in CS 2.0.2, a base profile that provides a basic set of information objects has to be supported by each catalogue instance; in addition, application profiles for different information communities can be specified.

Hence, this document specifies an application profile for ISO 19115:2003/ISO 19119:2005 metadata with support for XML encoding per ISO/TS19139:2007

---

<sup>1</sup> Spatial Data Infrastructure North Rhine Westphalia (federal state of Germany)

## OGC 07-045r2

[ISO/TS19139]<sup>2</sup> and HTTP protocol binding. It relies on requirements coming from the CS/CSW 2.0 specification (OGC CS 2.0.2, OGC document 07-006). The application profile will form the basis of conformance tests and reference implementations.

---

<sup>2</sup> Using the most recent ISO19139 XML schemas (May 4, 2006) which is available at the time of publication of this specification.

## OGC Web Services Initiative

### 1 Scope

This application profile document specifies the interfaces, bindings, and encodings required to publish and access digital catalogues of metadata for geospatial data, services, and applications that comply with the given profile. Metadata act as generalized properties that can be queried and returned through catalogue services for resource evaluation and, in many cases, invocation or retrieval of the referenced resources.

### 2 Conformance

Conformance with this specification shall be checked using all the relevant tests specified by the Abstract Test Suite (ATS) in Annex A (normative). The framework, concepts, and methodology for testing, and the criteria to be achieved to claim conformance are specified in ISO 19105: Geographic information — Conformance and Testing. Test data and queries are not included in this profile.

In addition to satisfying the requirements stipulated in all normative clauses and Annex A, a catalogue implementation must also satisfy all relevant requirements in the following base specifications:

- OGC Catalogue Services Specification 2.0.2, Clause 10 (OGC 07-006)
- OGC Web Services Common Specification 1.0 (OGC 05-008c1)
- OGC Filter Encoding Implementation Specification 1.1 (OGC 04-095)

### 3 Normative references

The following normative documents contain provisions that, through reference in this text, constitute provisions of this document. For dated references, subsequent amendments to, or revisions of, any of these publications do not apply. For undated references, the latest edition of the normative document referred to applies.

IETF RFC 2141 (May 1997), URN Syntax, R. Moats <http://www.ietf.org/rfc/rfc2141.txt>

## OGC 07-045r2

IETF RFC 2616 (June 1999), Hypertext Transfer Protocol – HTTP/1.1, Gettys, J., Mogul, J., Frystyk, H., Masinter, L., Leach, P., and Berners-Lee, T., eds., <http://www.ietf.org/rfc/rfc2616.txt>

IANA, Internet Assigned Numbers Authority, MIME Media Types, available at <http://www.iana.org/assignments/media-types/>

ISO/IEC TR 10000-1:1998. Information Technology – Framework and taxonomy of International Standardised Profiles – Part 1: General principles and documentation framework. Technical Report, JTC 1. Fourth edition. Available [online]: [http://www.iso.ch/iso/en/ittf/PubliclyAvailableStandards/c030726\\_ISO\\_IEC\\_TR\\_10000-1\\_1998\(E\).zip](http://www.iso.ch/iso/en/ittf/PubliclyAvailableStandards/c030726_ISO_IEC_TR_10000-1_1998(E).zip).

ISO/IEC 10746-2:1996. Information Technology – Open Distributed Processing – Reference Model: Foundations. Common text with ITU-T Recommendation X.902. Available [online]: [http://www.iso.ch/iso/en/ittf/PubliclyAvailableStandards/s018836\\_ISO\\_IEC\\_107462\\_1996\(E\).zip](http://www.iso.ch/iso/en/ittf/PubliclyAvailableStandards/s018836_ISO_IEC_107462_1996(E).zip).

ISO 19105:2000, Geographic information — Conformance and Testing.

ISO 19106:2003, Geographic Information – Profiles

ISO 19115:2003, Geographic information - Metadata (with ISO 19115:2003/Cor. 1:2006, Geographic information - Metadata - Technical Corrigendum 1)

ISO 19119:2005Amd 1:2008, Geographic Information – Services

ISO/CD 19136, Geographic Information – Geography Markup Language.

ISO/TS 19139:2007, Geographic information - Metadata - Implementation specification

ISO 639-2:2002, Codes for the representation of names of languages -- Part 2: Alpha-2 code(<http://www.w3.org/WAI/ER/IG/ert/iso639.htm>)

ISO 8601:2000, Data elements and interchange formats -- Information interchange -- Representation of dates and times

OGC 06-023r1, Definition identifier URNs in OGC namespace

OGC 99-113, OGC Abstract Specification Topic 13: Catalogue Services

OGC 02-112, OGC Abstract Specification Topic 12: OpenGIS Service Architecture

OGC 07-006, OpenGIS Catalogue Services Specification, v2.0.2 (Corrigendum Release 2).

OGC 04-095 OGC Filter Encoding Implementation Specification, version 1.1.0

OGC 05-008c1, OWS Common Implementation Specification

W3C Recommendation January 1999, Namespaces In XML, <http://www.w3.org/TR/2000/REC-xml-names>.



W3C Recommendation (16 November 1999): XML Path Language (XPath) Version 1.0, <http://www.w3.org/TR/xpath.html>

W3C Recommendation 6 October 2000, Extensible Markup Language (XML) 1.0 (Second Edition), <http://www.w3.org/TR/REC-xml>

W3C Recommendation 2 May 2001: XML Schema Part 0: Primer, <http://www.w3.org/TR/2001/REC-xmlschema-0-20010502/>

W3C Recommendation 2 May 2001: XML Schema Part 1: Structures, <http://www.w3.org/TR/2001/REC-xmlschema-1-20010502/>

W3C Recommendation 2 May 2001: XML Schema Part 2: Datatypes, <http://www.w3.org/TR/2001/REC-xmlschema-2-20010502/>

W3C Recommendation (24 June 2003): SOAP Version 1.2 Part 1: Messaging Framework, <http://www.w3.org/TR/SOAP/>

WSDL, Web Services Description Language (WSDL) 1.1. Available [online]: <http://www.w3.org/TR/wsdl>

In addition to this document, this specification includes several normative XML Schema files. These are available online at <http://schemas.opengis.net/>.

## 4 Terms and definitions

For the purposes of this specification, the definitions specified in Clause 4 of the *OGC Web Services Common Specification* [OGC 05-008c1] shall apply. In addition, the following terms and definitions apply:

### 4.1.

#### **Application profile**

set of one or more base standards and - where applicable - the identification of chosen clauses, classes, subsets, options and parameters of those base standards that are necessary for accomplishing a particular function [ISO 19101, ISO 19106]

### 4.2.

#### **client**

software component that can invoke an **operation** from a **server**

### 4.3.

#### **data level**

stratum within a set of layered levels in which data is recorded that conforms to definitions of types found at the application model level [ISO 19101]

**4.4.**

**dataset series (datasetcollection<sup>3</sup>)**

collection of datasets sharing the same product specification [ISO 19113, ISO 19114, ISO 19115]

**4.5.**

**geographic dataset**

dataset with a spatial aspect [ISO 19115]

**4.6.**

**geographic information**

information concerning phenomena implicitly or explicitly associated with a location relative to the Earth [ISO 19128 draft]

**4.7.**

**georesource**

geographic information of a specific type (e.g. geographic dataset, geographic application, geographic service)

**4.8.**

**identifier**

a character string that may be composed of numbers and characters that is exchanged between the client and the server with respect to a specific identity of a resource

**4.9.**

**interface**

named set of operations that characterise the behaviour of an entity [ISO 19119]

**4.10.**

**metadata dataset (metadataset)**

metadata describing a specific dataset [ISO 19101]

**4.11.**

**metadata entity**

group of metadata elements and other metadata entities describing the same aspect of data

NOTE 1 A metadata entity may contain one or more metadata entities.

NOTE 2 A metadata entity is equivalent to a class in UML terminology [ISO 19115].

**4.12.**

**metadata schema**

conceptual schema describing metadata

---

<sup>3</sup> Due to historical reasons we'll mainly use the term 'dataset collection' in this document although the term 'dataset series' is used in the ISO/TC211 Terminology Maintenance Group.

NOTE ISO 19115 describes a standard for a metadata schema. [ISO 19101]

#### 4.13.

##### **metadata section**

subset of metadata that defines a collection of related metadata entities and elements [ISO 19115]

#### 4.14.

##### **operation**

specification of a transformation or query that an object may be called to execute [ISO 19119]

#### 4.15.

##### **parameter**

variable whose name and value are included in an operation **request** or **response**

#### 4.16.

##### **qualified name**

name that is prefixed with its naming context

EXAMPLE The qualified name for the road no attribute in class Road defined in the Roadmap schema is RoadMap.Road.road\_no. [ISO 19118].

#### 4.17.

##### **request**

invocation of an **operation** by a **client**

#### 4.18.

##### **resource**

an object or artefact that is described by a record in the information model of a catalogue

#### 4.19.

##### **response**

result of an **operation**, returned from a **server** to a **client**

#### 4.20.

##### **schema**

formal description of a model [ISO 19101, ISO 19103, ISO 19109, ISO 19118]

#### 4.21.

##### **server**

##### **service instance**

a particular instance of a **service** [ISO 19119]

#### 4.22.

##### **service**

distinct part of the functionality that is provided by an entity through interfaces [ISO 19119]

capability which a service provider entity makes available to a service user entity at the interface between those entities [ISO 19104 terms repository]

**4.23.**

**service interface**

shared boundary between an automated system or human being and another automated system or human being [ISO 19101]

**4.24.**

**service metadata**

metadata describing the **operations** and **geographic information** available at a **server** [ISO 19128 draft]

**4.25.**

**state**

condition that persists for a period

NOTE The value of a particular feature attribute describes a condition of the feature [ISO 19108].

**4.26.**

**transfer protocol**

common set of rules for defining interactions between distributed systems [ISO 19118]

**4.27.**

**version**

version of an Implementation Specification (document) and XML Schemas to which the requested operation conforms

NOTE An OWS Implementation Specification version may specify XML Schemas against which an XML encoded operation request or response must conform and should be validated.

## **5 Conventions**

### **5.1 Symbols (and abbreviated terms)**

Some frequently used abbreviated terms:

API Application Program Interface

COTS Commercial Off The Shelf

CQL Common Query Language

CRS Coordinate Reference System

CSW Catalogue Service-Web

DCE Distributed Computing Environment

DC Dublin Core  
DCMI Dublin Core Metadata Initiative  
DCP Distributed Computing Platform  
HTTP HyperText Transfer Protocol  
ISO International Organisation for Standardisation  
OGC Open GIS Consortium  
SOAP Simple Object Access Protocol  
SQL Structured Query Language  
UML Unified Modeling Language  
URI Uniform Resource Identifier  
URL Uniform Resource Locator  
URN Uniform Resource Name  
UTF-8 Unicode Transformation Format-8  
WSDL Web Service Definition Language  
W3C World Wide Web Consortium  
XML eXtensible Markup Language

Most of the abbreviated terms listed in Subclause 5.1 of the OWS Common Implementation Specification [OGC 05-008c1] also apply to this document.

## 5.2 UML notation

Some of the diagrams in this document are presented using the Unified Modeling Language (UML) static structure diagram. The UML notations used in this document are described in Figure 1, below.

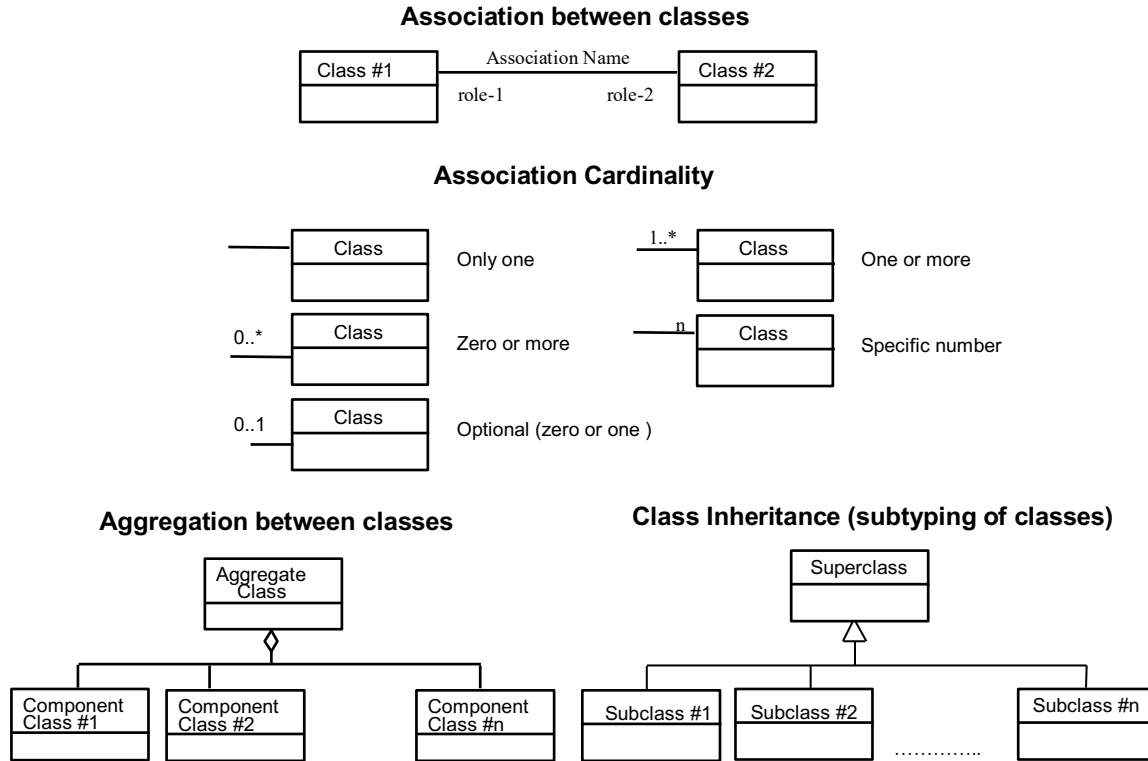

**Figure 1 UML notations**

In these UML class diagrams, the class boxes with a light background are the primary classes being shown in this diagram, often the classes from one UML package. The class boxes with a gray background are other classes used by these primary classes, usually classes from other packages.

In this diagram, the following stereotypes of UML classes are used:

- <<Interface>> A definition of a set of operations that is supported by objects having this interface. An Interface class cannot contain any attribute.
- <<Type>> A stereotyped class used for specification of a domain of instances (objects), together with the operations applicable to the objects. A Type class may have attributes and associations.

- <<DataType>> A descriptor of a set of values that lack identity (independent existence and the possibility of side effects). A DataType is a class with no operations whose primary purpose is to hold the information.
- <<CodeList>> A flexible enumeration that uses string values for expressing a list of potential values. If the list alternatives are completely known, an enumeration shall be used; if the only likely alternatives are known, a code list shall be used.
- <<Enumeration>> A data type whose instances form a list of alternative literal values. Enumeration means a short list of well-understood potential values within a class.

In this document, the following standard data types are used:

- `CharacterString` – A sequence of characters
- `Boolean` – A value specifying TRUE or FALSE
- `Integer` – An integer number
- `Identifier` – Unique identifier of an object
- `URI` – An identifier of a resource that provides more information
- `URL` – An identifier of an on-line resource that can be electronically accessed

### 5.3 Document terms and definitions

This document uses the specification terms defined in Subclause 5.3 of [OGC 05-008c1].

## 6 System context

This section focuses on the purpose, scope and policies of catalogue services that comply with the given profile. It documents special requirements and describes the context of use.

### 6.1 Application domain

A metadata repository managed by a catalogue implementing this application profile deals with metadata about geospatial data, geospatial services and geospatial applications.

It is intentional that the profile specified in this document does not attempt to specify a general-purpose catalogue. Rather, it allows the retrieval and management of the metadata objects referred to above.

This application profile has no specific disciplinary focus. All communities working with these sorts of geospatial information are addressed. Typical communities are surveying, environment, geology, landscaping, water management, power industry, telecommunications etc.

## OGC 07-045r2

The intention is to implement a generally understood information model based on standard metadata with only a few relationships among the catalogue items. Usage should be as simple as possible, implementing a set of use cases typical in the geospatial community.

The requirements of the information model, search properties, details of the results sets and interfaces were defined in close cooperation with users in various communities as well as software vendors.

This profile allows for a catalogue to accept a request from a client and distribute the request to one or more other catalogues within a federation. In this case, the metadata entries managed by the other catalogues become available to their own clients. It is possible to start a search from only one known location and to search as many catalogues as possible with the same set of attributes.

### 6.2 Essential use cases

This section describes essential use cases for the purpose of demonstrating typical interactions between users, as well as a catalogue service that supports the specified application profile. Figure 2 shows the overall system that contains major interactions between the actors.

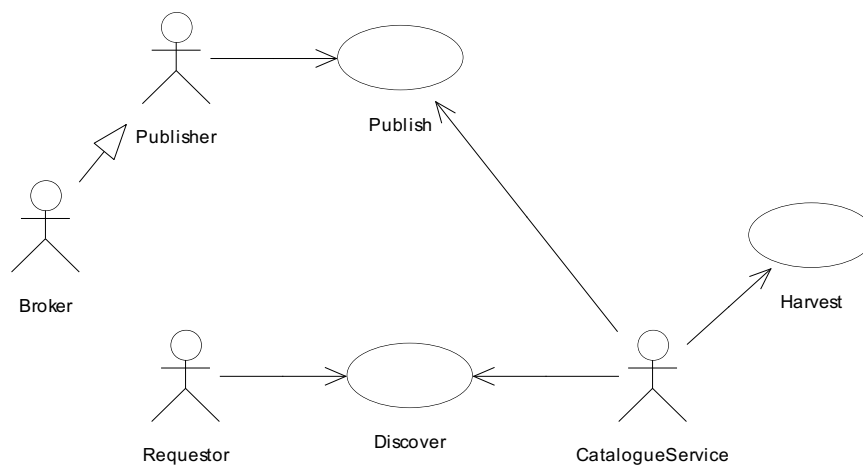

**Figure 2: Overall system use cases**

An actor is a person, organisation, or external system that plays a role in one or more interactions with the system. Four actors are identified:

**Publisher:** A publisher publishes metadata descriptions to a catalogue. By doing so, he enables the discovery of that description record by a requestor entity. This actor is also the owner of the geo-resource that he describes.

**Broker:** This actor is a specialised publisher that publishes and maintains metadata records on behalf of the owner of georesources.



**Requestor:** This actor searches for metadata records in a catalogue service, either by browsing or through more complicated queries.

**Catalogue Service:** This is a system that handles the discovery and publishing of metadata entries. Furthermore, this actor has the ability to harvest metadata records from other catalogue services.

The following sections describe the use cases in more detail.

### 6.2.1 Publish metadata

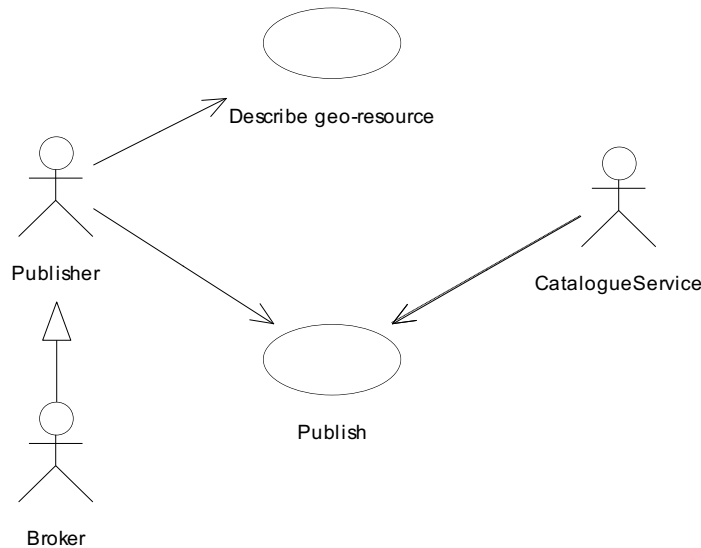

**Figure 3: Publish metadata**

**Description:** A publisher describes geo-resources by applying ISO/TS19139 [ISO/TS19139] as specified by this document. A geo-resource might be a service, a geodataset (single or collection) or an application. The publisher owns the georesource. As an alternative, the publisher might be a broker that does not own the geo-resource, but describes and publishes metadata descriptions to a catalogue service on behalf of a publisher.

**Pre-conditions:** The publisher knows the URL of the catalogue service has knowledge about the transaction interface and has the right to access the catalogue service.

**Post-conditions:** The metadata record is either successfully published to the catalogue service or publishing fails due to a non-valid metadata description.

### 6.2.2 Discover metadata

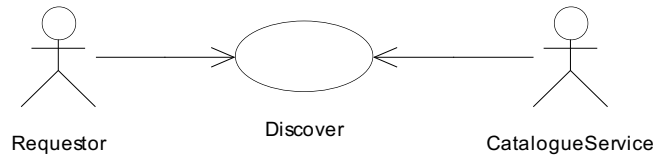

**Figure 4: Discover metadata**

**Description:** A requestor discovers metadata entries in a catalogue service either by browsing the content of the catalogue or by placing certain query terms. If a service is discovered that fits his search terms, he can bind to this service in accordance with the information in the result sets of the catalogue service.

**Pre-conditions:** The requestor knows the location of the catalogue service.

**Post-Condition:** The requestor receives a valid catalogue response (due to a valid request) with a result set that contains all the information that fits the requestor’s query.

### 6.2.3 Harvest metadata

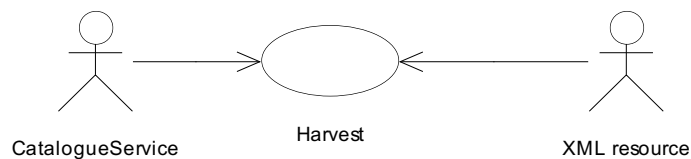

**Figure 5: Harvest metadata**

**Description:** A catalogue service may harvest metadata records from a given XML resource, i.e. a metadata description that complies with XML schemas provided by this specification. This could be a metadata description of services or geodata or, additionally in case of services, a capabilities document of an OGC service that complies with OGC Common Implementation Specification.

**Pre-conditions:** The resource complies with the schemas given by this profile<sup>4</sup>. The XML resource must be accessible over a network.

**Post-Condition:** If the request is processed successfully, the XML resource is inserted into the catalogue storage and is available immediately in case of an adequate query.

---

<sup>4</sup> or is a capabilities document which must a priori be translated into the schema given by this profile.

## 7 Information models

This view focuses primarily on the information structures and the semantics of information processing (i.e. what the system is about); it describes the public information model that is employed by the catalogue service and the interfaces through which it is accessed. The syntax for all supported representations of the metadata objects is defined.

NOTE Mappings to information objects are described by using qualified names according to ISO 19118. For example, the qualified name of resource constraints of a resource being described in a metadata record is MD\_Identification.resourceConstraints.

### 7.1 Capability classes

This section defines the capability classes of the catalogue service. The application profile distinguishes several capability classes based on the general catalogue information model.

Since both the OGC\_Service and the Discovery functions must be provided by all conforming implementations, they are a mandatory part of the capability class (CSW-Catalogue). A 'read-only' catalogue service has to provide operations labeled 'CSW'. In addition, a transactional catalogue service has to provide operations labeled 'CSWT'.

The additional Manager functions, providing a standardized interface for the active management (push-model) or the passive harvesting (pull-model) of metadata is mandated to be an optional part of the profile (CSWT Catalogue).

**Table 1 - Operations provided by CSW capability classes**

| Capability class label | Operations provided  |
|------------------------|--|
| CSW                    | OGC_Service.GetCapabilities<br>CSW Discovery.DescribeRecord<br>CSW Discovery.GetRecords<br>CSW Discovery.GetDomain (optional)<br>CSW Discovery.GetRecordById |
| CSWT                   | As above, plus:<br>CSW Manager.Harvest<br>CSW Manager.Transaction  |

All mandatory and optional classes and their associated operations are listed in Table 1.

The logical model of the capability classes is described in the following figure:

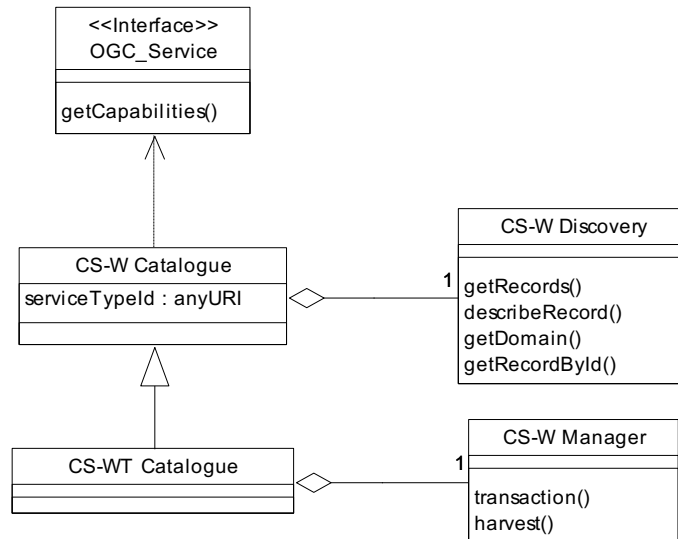

**Figure 6: CSW capability classes**

OGC\_Service – This interface is the logical representation of any OGC-compliant service. It defines the `getCapabilities()` operation;

CSW\_Catalogue – Implements the OGC\_Service interface. This class provides simple synchronous discovery, but no asynchronous discovery is supported. A CSW compliant catalogue must implement at least this functionality<sup>5</sup>.

CSWT\_Catalogue – This class is a specialization of the CSW\_Catalogue. It provides transactional capabilities and is optional.

## 7.2 Catalogue information model

The CSW information model is based on the international standard for metadata description ISO 19115:2003/Cor.1:2006<sup>6</sup>. In addition, the catalogue uses a metadata description for service metadata based on the ISO 19119:2005/Amd 1:2008<sup>7</sup> standard [ISO 19119] to facilitate the management of service metadata. The encoding of any information object in this profile is based on ISO/TS19139:2007 [ISO/TS19139]. The main purpose of the information model is to provide a formal structure for the description of information resources that can be managed by a catalogue service that complies with the application profile.

<sup>5</sup> Except the `getDomain()` operation, which is optional.

<sup>6</sup> `metadataStandardName: 'ISO19115', metadataStandardVersion: '2003/Cor.1:2006'`

<sup>7</sup> `metadataStandardName: 'ISO19119', metadataStandardVersion: '2005/Amd 1: 2008'`

19115:2003/Cor.1:2006 specifies a general purpose model for metadata descriptions. In the following section, this document only refers to the changes that have been applied to 19115:2003/Cor.1:2006 and ISO 19119:2005/Amd 1:2008 to set up the information model for this application profile. For a more comprehensive description of the model please refer to the original specification documents.

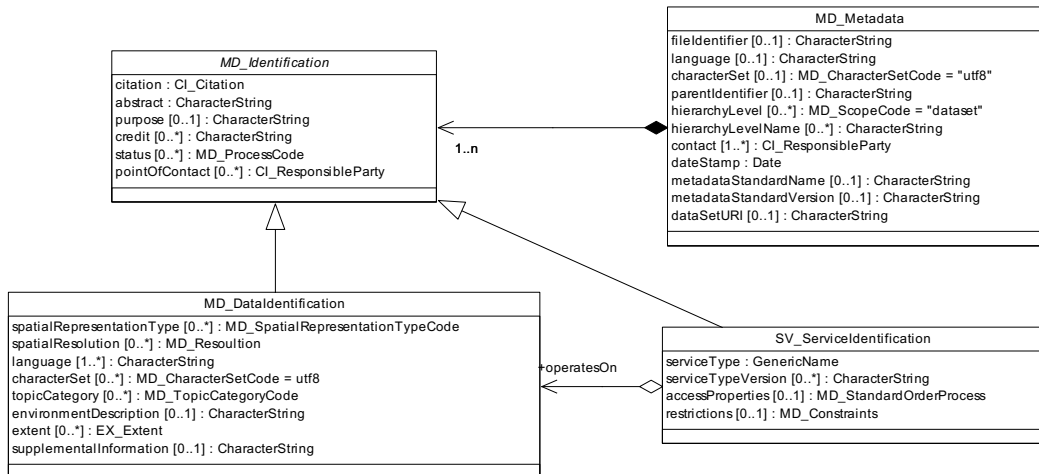

**Figure 7: Basic classes - Excerpt from 19115:2003/Cor.1:2006**

Figure 7 gives a high level overview of the basic classes of the information model. The classes belong to basic packages that are specified by 19115:2003/Cor.1:2006.

**Table 2 - Class descriptions**

| Class name            | Description  |
|-----------------------|--|
| MD_Metadata           | Contains Metadata entity set information. The MD_Metadata entity is a composite of MD_Identification and further classes that are suppressed due to clarity, but explained in detail in 19115:2003/Cor.1:2006. [ISO19115:2003 A.2.1]               |
| MD_Identification     | This abstract class contains information to uniquely identify the information resource that has to be described. MD_Identification is mandatory. It may be implemented as MD_DataIdentification or SV_ServiceIdentification. [ISO19115:2003 A.2.2] |
| MD_DataIdentification | Subclass and concretion of the abstract class MD_Identification. According to the application profile, MD_DataIdentification describes either data or applications. [ISO19115:2003 A.2.2]  |

|                          |   |
|--------------------------|---|
| SV_ServiceIdentification | Subclass and concretion of the abstract class MD_Identification. SV_ServiceIdentification gives a high level description of services according to ISO19119:2005/Amd 1:2008. A service might be 'loosely coupled' (with no associated data), 'tightly coupled' (with associated data) or 'mixed coupled'. This distinction is done by setting the couplingType attribute of the SV_ServiceIdentification class [see also ISO19119:2005/Amd 1:2008 7.4.2] |
|--------------------------|---|

### 7.2.1 Information Resources

Information resources are entities that can be managed by a CSW-compliant catalogue service. These resources are described and encoded based on the supported information model. The CSW information model supports the description of the following information resources:

**Table 3: Information resources**

| <b>Information resource</b> | <b>Description</b>   | <b>Logical model</b> |
|-----------------------------|--|----------------------|
| Dataset <sup>8</sup>        | An identifiable collection of data   | ISO 19115            |
| Datasetcollection           | A collection of datasets sharing the same product specification  | ISO 19115            |
| Service                     | A service instance hosted on a specific set of hardware and accessible over a network. A service is tightly coupled, loosely coupled or mixed coupled.   |                      |
| Loosely coupled             | A service instance that is not associated with a specific dataset or datasetcollection. Loosely-coupled services may have an association with data types through the service type definition. Dataset metadata need not be provided in the service metadata. | ISO 19119            |

---

<sup>8</sup> Documents (e.g. .pdf with geospatial content) should be described as a dataset.

|                 |   |                     |
|-----------------|---|---------------------|
| Tightly coupled | A service that is associated with specific datasets or datasetcollections. Service metadata shall describe both the service and the geographic dataset, the latter being defined in accordance with ISO 19115.  | ISO 19119/ISO 19115 |
| Mixed coupled   | A service that is associated with a specific dataset or datasetcollection. Service metadata shall describe both the service and the geographic dataset, the latter being defined in accordance with ISO 19115. But this service instance can also be used with external data (i.e. data that is not described by the operatesOn association). | ISO 19119/ISO 19115 |
| Application     | An information resource that is hosted on a specific set of hardware and accessible over a network.   | ISO 19115           |

In the following you find a mapping of the ISO19115/19 metadata information objects to these information resources.

#### 7.2.1.1 Datasets and datasetcollections

Metadata descriptions of geographic datasets and datasetcollections are completely covered by 19115:2003/Cor.1:2006. No further extensions have been made to this profile.

Furthermore, according to 19115:2003/Cor.1:2006, profiles may be defined that may have additional elements. These profile extensions may be used in connection with the information model at hand, but may not contradict 19115:2003/Cor.1:2006, ISO19119:2005/Amd 1:2008 or the extensions being made in this document.

#### 7.2.1.2 Service (loosely-/tightly-/mixed-coupled)

Next to datasets and datasetcollections, the catalogue service manages service instance metadata. ISO19119:2005/Amd 1:2008 1 defines metadata for the description of geographic service instances. These records can be managed and searched using a catalogue service in a similar manner to the metadata entities described in the previous section. The metadata elements for a service provide sufficient information to allow a client to invoke the service based on the metadata record.

A common use case in the context of catalogue services is that someone searches for services providing specific data. Such behaviour can be modeled by ISO19119 [ISO 19119:2005/Amd 1:2008] where a service instance: “[...] *may be tightly-coupled with a dataset instance, or it may be un-associated with specific data instances, i.e. loosely-coupled. Loosely-coupled services may have an association with data types through the service type definition. In the tightly-coupled case, the service metadata shall describe*

## OGC 07-045r2

*both the service and the geographic dataset, the latter being defined in accordance with ISO 19115.... For the loosely-coupled case, dataset metadata need not be provided in the service metadata.”*

As a result service metadata descriptions consist of the following parts:

- Identification information as `serviceType` and `serviceTypeVersion`, identification information inherited from ISO19115:MD\_ Identification and optional access properties and restrictions
- Metadata describing the service instance (operations and parameters) including the DCP-dependent `connectPoints` (service endpoints) of the operations, ideally a linking WSDL document including constraints on the permitted values of the service operations (primary in the tightly-coupled-case).
- Optional Metadata (19115:2003/Cor.1:2006) or references, describing the geodata with which the service may be associated.

In the context of this application profile, service metadata is described by ISO 19119:2005/Amd 1:2008. See Annex D1 for a detailed description of the XML encoding for services.

### 7.2.1.3 Applications

In the context of this profile, an application is defined as an information resource that is accessible over the Internet and does not fit into the category of services described in the above sections. They are primarily clients (here: HTTP-based) with a specialised, proprietary user interface. For that reason, they can be described by a valid ISO 19115:2003/Cor.1:2006 metadata entry, including an online link to their location.

## 7.2.2 Extensions

The application profile at hand demands some extensions to the referenced ISO specifications. These extensions and recommendations are described in the following paragraphs.

### 7.2.2.1 Extensions to ISO 19115:2003/Cor.1:2006

To support the description of the resource type ‘application’ the list of possible values for the ISO class `MD_ScopeCode` has to be extended.

The following value has to be added to the data dictionary of the `MD_ScopeCode` class defined by ISO 19115:2003/Cor.1:2006.



**Table 4 - Data dictionary for MD\_ScopeCode <<CodeList>>**

|    | Name         | Domain code | Definition   |
|----|--------------|-------------|--|
| 1  | MD_ScopeCode | ScopeCd     | class of information to which the referencing entity applies |
| 1. | Application  | 017         | information applies to the application                       |

Admittedly, some recommendations are made to clarify the usage of specific elements of a metadata entity. These recommendations are as follows:

`MD_Metadata.fileIdentifier`: unique identifier for the given metadata entity. This identifier is mandatory for this application profile!<sup>9</sup> The usage of a UUID (Universal Unique Identifier, as specified by IETF (<http://www.ietf.org>)) is recommended to ensure identifier's uniqueness.

`MD_Metadata.parentIdentifier`: unique identifier for a datasetcollection that is described elsewhere and which the metadata entity belongs to. The usage of a UUID (Universal Unique Identifier, as specified by IETF (<http://www.ietf.org>)) is recommended to ensure identifier's uniqueness.

To simplify catalogue mining each `MD_DataIdentification` instance being part of a `MD_Metadata` instance must have an identifier having a code value that is equal to the `fileIdentifier` of the owning `MD_Metadata` instance.

#### 7.2.2.2 Extensions to 19119:2005/Amd 1:2008

One minor extension has to be applied to the class <<SV\_CoupledResource>>. The original class <<SV\_CoupledResource>> does not allow to consider the name of the resources (i.e. dataset) as it is used by a service instance (e.g. layer name or `featureTypeName`). Thus, there is no method to generate service requests (like `GetMap` or `GetFeature`) based on plain ISO service metadata.

In addition there exists a more general problem in the scope of coupling service and data metadata, since there exists a wide range of possible interpretations and usages of elements intended for this issue.

For that reason a convenient way when implementing and using CSW with ISO Application Profile to specify interpretation of these elements is suggested in Figure 8 .

---

<sup>9</sup> precondition for the `getRecordById` operation to work properly (see 8.2.2.2)

|                                   |
|-----------------------------------|
| SV_CoupledResource                |
| + identifier : CharacterString    |
| + operationName : CharacterString |
| + ScopedName : CodeType           |
|                                   |

**Figure 8: Extension to class <<SV\_CoupledResource>>**

**Table 5 — Data dictionary for SV\_CoupledResource**

|    | Attribute name/Role name | Definition   | Obligation/Condition | Maximum occurrence | Data type       |
|----|--------------------------|--|----------------------|--------------------|-----------------|
| 1. | operation name           | Name of the service operation  | M                    | 1                  | CharacterString |
| 2. | identifier               | Name of the identifier of a given tightly coupled dataset                      | M                    | 1                  | CharacterString |
| 3. | ScopedName               | Scoped identifier of the resource in the context of the given service instance | O                    | 1                  | CodeType        |

The XML schema fragment is defined in Annex D2 accordingly.

A gmd:MD\_Metadata element that uses this extension should describe it properly by offering a gmd:metadataExtensionInfo property. In the service metadata operation section, the client should find sufficient information to bind to the service, including access point information for the GetCapabilities-operation.

### 7.2.3 Mappings to the common XML Record format

#### 7.2.3.1 Core queryable properties

The queryable properties are those properties on which a catalogue client can formulate a filter expression. The goal of defining core queryable properties is primarily query interoperability among catalogues that implement the same protocol binding. Defining a set of core queryable properties also enables simple cross-profile discovery, where the same queries can be executed against any catalogue service without modification and without detailed knowledge of the catalogue's information model. This requires a set of general metadata properties that can be used to characterize any resource.

**All queryables must be expressed as qualified names (QNames).**

The following tables define the mapping of the core queryable properties (as defined by the OGC Catalogue specification) to the ISO information model.

The properties “Title”, “AnyText”, and “Identifier” are mandatory queryables. Core queryable properties that cannot have a value assigned (e.g. the information is not available in the information model of the catalogue instance) shall be considered as having a value of NULL.

**Table 6 – Mapping to common queryable elements**

| Name                    | Definition   | Data type  | Property Mapping to Information Model  |
|-------------------------|--|--|--|
| Subject <sup>a</sup>    | The topic of the content of the resource <sup>b</sup>                | CharacterString  | MD_Metadata.identificationInfo.AbstractMD_Identification.descriptiveKeywords.MD_Keywords.keyword<br><br>plus<br>MD_Metadata.identificationInfo.MD_DataIdentification.topicCategory |
| Title <sup>a</sup>      | A name given to the resource   | CharacterString  | MD_Metadata.identificationInfo.AbstractMD_Identification.citation.CI_Citation.title  |
| Abstract <sup>a</sup>   | A summary of the content of the resource.                            | CharacterString  | MD_Metadata.identificationInfo.AbstractMD_Identification.abstract  |
| AnyText                 | A target for full-text search of character data types in a catalogue | CharacterString  | Whole resource text.   |
| Format <sup>a</sup>     | The physical or digital manifestation of the resource <sup>f</sup>   | CharacterString  | MD_Metadata.distributionInfo.MD_Distribution.distributionFormat.MD_Format.name   |
| Identifier <sup>a</sup> | A unique reference to the record within the catalogue                | Identifier   | MD_Metadata.fileIdentifier   |
| Modified <sup>c</sup>   | Date on which the record was created or updated within the catalogue | Date-8601, example: 1963-06-19   | MD_Metadata.dateStamp.Date   |
| Type <sup>a</sup>       | The nature or genre of the content of the resource. Type can         | Codelist: dataset, datasetcollection, service, application <sup>10</sup> | MD_Metadata.hierarchyLevel.MD_ScopeCode/@codeListValue. If MD_Metadata.hierarchyLevel is missing, ‘Type’ will be   |

<sup>10</sup> The additional type value “application” can only be used in a query against a catalogue compliant to this profile

**OGC 07-045r2**

|                          |   |                          |   |
|--------------------------|---|--------------------------|---|
|                          | include general categories, genres or aggregation levels of content. <sup>g</sup> |                          | considered as “Dataset” (default).          |
| BoundingBox <sup>d</sup> | A bounding box for identifying a geographic area of interest                      | BoundingBox, see Table 7 | BoundingBox.<br>see Table 7                 |
| CRS <sup>e</sup>         | Geographic Coordinate Reference System (Authority and ID) for the BoundingBox     | Identifier               | CRS,<br>see Table 8                         |
| <i>Association</i>       | Complete statement of a one-to-one relationship                                   | Association              | There is no mapping defined in this profile |

a Names, but not necessarily the identical definition, are derived from the Dublin Core Metadata Element Set, version 1.1:ISO Standard 15836-2003 (February 2003)

b Typically, a Subject will be expressed as keywords, key phrases or classification codes that describe a topic of the resource. Recommended best practice is to select a value from a controlled vocabulary or formal classification scheme.

c DCMI metadata term <<http://dublincore.org/documents/dcmi-terms/>>.

d Same semantics as EX\_GeographicBoundingBox class in ISO 19115.

e If not supplied, the BoundingBox CRS has to be WGS84

f Dublin Core Metadata Element Set, version 1.1:ISO Standard 15836-2003: Typically, Format may include the media-type or dimensions of the resource. Format may be used to determine the software, hardware or other equipment needed to display or operate the resource.

g Dublin Core Metadata Element Set, version 1.1:ISO Standard 15836-2003. The core queryable Type is used to indicate the type or class of a resource being described by the catalogue. Typically the value of the Type property is taken from some controlled vocabulary. To describe the physical or digital manifestation of the resource, use the FORMAT element.

**Table 7 - Composition of compound element “BoundingBox”**

| Name               | Definition   | Data type | Property Mapping to Information Model   |
|--------------------|--|-----------|---|
| WestBoundLongitude | Western-most coordinate of the limit of the resource’s extent, expressed in longitude in decimal degrees (positive east)   | numeric   | MD_Metadata.identificationInfo.MD_DataIdentification.extent.EX_Extent.geographicElement.EX_GeographicBoundingBox.westBoundLongitude |
| SouthBoundLatitude | Southern-most coordinate of the limit of the resource’s extent, expressed in latitude in decimal degrees (positive north)  | numeric   | MD_Metadata.identificationInfo.MD_DataIdentification.extent.EX_Extent.geographicElement.EX_GeographicBoundingBox.southBoundLatitude |
| EastBoundLongitude | Eastern-most coordinate of the limit of the resource’s extent, expressed in longitude in decimal degrees (positive east)   | numeric   | MD_Metadata.identificationInfo.MD_DataIdentification.extent.EX_Extent.geographicElement.EX_GeographicBoundingBox.eastBoundLongitude |
| NorthBoundLatitude | Northern-most, coordinate of the limit of the resource’s extent, expressed in latitude in decimal degrees (positive north) | numeric   | MD_Metadata.identificationInfo.MD_DataIdentification.extent.EX_Extent.geographicElement.EX_GeographicBoundingBox.northBoundLatitude |

**Table 8 - Composition of compound element “CRS”**

| Name  | Definition                                  | Data type        | Property Mapping to Information Model  |
|---|---|------------------|--|
| Authority   | Authority of the CRS                        | Character String | MD_Metadata.referenceSystemInfo.MD_ReferenceSystem.referenceSystemIdentifier.RS_Identifier.codeSpace |
| ID  | ID of the CRS                               | Character String | MD_Metadata.referenceSystemInfo.MD_ReferenceSystem.referenceSystemIdentifier.RS_Identifier.code      |
| Version   | Version to which the CRS encoding refers to | Character String | MD_Metadata.referenceSystemInfo.MD_ReferenceSystem.referenceSystemIdentifier.RS_Identifier.version   |
| To encode the element triplet as a string the following schema shall be considered (see clause 7.2 of OGC 06- |   |                  |  |

```
023r1):
urn:ogc:def:objectType:authority:version:code

With
  objectType = "crs"
  authority =<Authority>
  version=<Version>
  code=<ID>

Example: WGS84 as defined by version 6.3 of the EPSG standard would be encoded as follows:
urn:ogc:def:crs:EPSG:6.3:4326
```

### 7.2.3.2 Core returnable properties

The following table lists the mapping between core returnable properties and properties defined by this profile.

**Table 9 - Mapping to common returnable properties**

| Dublin Core metadata element name | Definition   | Property Mapping to ISO19139 Information Model   |
|-----------------------------------|--|--|
| title                             | A name given to the resource.  | MD_Metadata.identificationInfo.AbstractMD_Identification.citation.CI_Citation.title  |
| creator                           | An entity primarily responsible for making the content of the resource         | MD_Metadata.identificationInfo.AbstractMD_Identification.pointOfContact.CI_ResponsibleParty.organisationName[role.CI_RoleCode@codeList Value='originator']                         |
| subject                           | A topic of the content of the resource.  | MD_Metadata.identificationInfo.AbstractMD_Identification.descriptiveKeywords.MD_Keywords.keyword<br><br>plus<br>MD_Metadata.identificationInfo.MD_DataIdentification.topicCategory |
| description                       | An account of the content of the resource                                      | MD_Metadata.identificationInfo.AbstractMD_Identification.abstract  |
| publisher                         | An entity responsible for making the resource available.                       | MD_Metadata.identificationInfo.AbstractMD_Identification.pointOfContact.CI_ResponsibleParty.organisationName[role.CI_RoleCode@codeList Value='publisher']                          |
| contributor                       | An entity responsible for making contributions to the content of the resource. | MD_Metadata.identificationInfo.AbstractMD_Identification.pointOfContact.CI_ResponsibleParty.organisationName[role.CI_RoleCode@codeList Value='author']                             |
| date                              | The date of a  | MD_Metadata.dateStamp.Date   |

|            |   |  |
|------------|---|--|
|            | creation or update event of the catalogue record              |  |
| type       | The nature or genre of the content of the resource.           | MD_Metadata.hierarchyLevel.MD_ScopeCode@codeListValue <sup>11</sup>  |
| format     | The physical or digital manifestation of the resource.        | MD_Metadata.distributionInfo.MD_Distribution.distributionFormat.MD_Format.name   |
| identifier | A unique reference to the record within the catalogue         | MD_Metadata.fileIdentifier   |
| source     | Source  | not supported  |
| language   | A language of the intellectual content of the catalog record. | MD_Metadata.language   |
| relation   | A reference to a related resource.                            | MD_Metadata.identificationInfo.AbstractMD_Identification.aggregationInfo   |
| coverage   | The spatial extent or scope of the content of the resource    | BoundingBox.<br>see Table 7  |
| rights     | Information about rights held in and over the resource        | MD_Metadata.identificationInfo.AbstractMD_Identification.resourceConstraints.MD_LegalConstraints.accessConstraints@codeListValue |

#### 7.2.4 Additional search properties

In addition to the core queryables, the following queryable properties<sup>12</sup> are defined<sup>13</sup>. A catalogue service instance should advertise all supported queryable properties in its capabilities document (see 7.5).

The following items have to be considered with regard to the handling of queryables defined by this profile:

- If a catalogue record is associated with a null-value for queryable X then this records does not fulfill any query constraint on that queryable X except “is Null”.

<sup>11</sup> If *MD\_Metadata.hierarchyLevel* is missing, ‘Type’ will be considered as “dataset” (default).

<sup>12</sup> The main idea of using barewords also for the additional ISO queryables was to enhance search interoperability. The queryables can be seen as concepts and the mappings defined here to the ISO19139 schema can be seen as a proposal (or examples, to clarify the semantic of the concepts), in this case directly usable for ISO19115/19/39. In practice the materialization of the queryable concepts (and also the returnables) will be done by the implementation. With the barewords approach it would also be easier for a FGDC or ANZLIC metadata model based catalogue server also to support the ISO profile. It has the ability to map the ISO concepts to its FGDC or ANZLIC metadata model and vice versa (e.g. returning ISO19139 encoding from within a FGDC or ANZLIC metadata model). The queryables must be handled in a case-sensitive manner.

<sup>13</sup> For a catalogue instance it may also be possible to define further additional queryable properties(see 7.5).

## OGC 07-045r2

- If typeName equals to “csw:Record” no ISO metadata profile specific queryables must be used. The handling of the queryables is as defined as in chapter 10.8.4.11 of OGC 07-006.
- If the typeNames attribute of a query equals to ‘gmd:MD\_Metadata’ (‘gmd’ representing the ‘http://www.isotc211.org/2005/gmd’ namespace) any queryable that is part of the associated filter must be represented by a qualified name with a prefix (e.g. ‘apiso’), representing the ‘http://www.opengis.net/cat/csw/apiso/1.0’ namespace. This is true for both application profile queryables as well as for the OGC common core queryables (which are mapped to the gmd metadata schema then). Case sensitivity is as follows: For the common queryables use the same case as defined in the base specification (e.g. ‘apiso:title’), for the additional queryables use the cases as defined in this profile (tables 9-14), e.g. ‘apiso:RevisionDate’.
- The support of Xpath expressions as queryables (e.g. /gmd:MD\_Metadata/gmd:fileIdentifier/gco:CharacterString) is optionally supported (see 7.5).
- If a filter statement includes queryables that cannot be applied to a specific type (e.g.: type = “dataset” && ServiceTypeVersion = “WCS”) the server shall return an empty result set.
- If ‘OperatesOnIdentifier’ is used in a query then ‘OperatesOnName’ is mandatory and vice versa. Otherwise the resulting query expression is semantically incorrect.

These search properties are grouped by the information resource (see also the “type” queryable) they can be applied to. However, there are also additional search properties common to all information resources.

**Table 10 - Additional queryable properties common to all information resources**

| Name           | Definition                      | Data type                      | Property Mapping to Information Model  |
|----------------|---------------------------------|--------------------------------|--|
| RevisionDate   | Revision date of the resource   | Date-8601, example: 2006-06-07 | MD_Metadata.identificationInfo.AbstractMD_Identifier.citation.CI_Citation.date.CI_Date[dateType.CI_DateTypeCode.@codeListValue='revision'].date.Date |
| AlternateTitle | Alternate title of the resource | CharacterString                | MD_Metadata.identificationInfo.AbstractMD_Identifier.citation.CI_Citation.alternateTitle   |
| CreationDate   | Creation Date of the resource   | Date-8601, example: 1963-06-19 | MD_Metadata.identificationInfo.AbstractMD_Identifier.citation.CI_Citation.date.CI_Date[dateType.CI_DateTypeCode.@codeListValue='creation'].date.Date |



|                        |   |  |   |
|------------------------|---|--|---|
| PublicationDate        | Publication Date of the resource  | Date-8601, example: 1963-06-19   | MD_Metadata.identificationInfo.AbstractMD_Identification.citation.CI_Citation.date.CI_Date[dateType.CI_DateTypeCode.@codeListValue='publication'].date.Date |
| OrganisationName       | Name of the organisation providing the resource                           | CharacterString  | MD_Metadata.identificationInfo.AbstractMD_Identification.pointOfContact.CI_ResponsibleParty.organisationName  |
| HasSecurityConstraints | Are there any security constraints?                                       | Boolean (CharacterString), one of “true” or “false”                                | MD_Metadata.AbstractMD_Identification.resourceConstraints.MD_SecurityConstraints <sup>14</sup>  |
| Language               | Language of the metadata  | CharacterString: ISO 639-2:2002 language codes (three letters)                     | MD_Metadata.language  |
| ResourceIdentifier     | Identifier of the resource  | Identifier   | MD_Metadata.identificationInfo.AbstractMD_Identification.citation.CI_Citation.identifier.MD_Identifier.code   |
| ParentIdentifier       | Fileidentifier of the metadata to which this metadata is a subset (child) | Identifier   | MD_Metadata.parentIdentifier  |
| KeywordType            | Methods used to group similar keywords                                    | Codelist (MD_KeywordTypeCode), one of: discipline, place, stratum, temporal, theme | MD_Metadata.identificationInfo.AbstractMD_Identification.descriptiveKeywords.MD_Keywords.type   |

For information resources of the types ‘dataset’, ‘datasetcollection’ and ‘application’, the following additional search properties should be supported.

**Table 11 - Additional queryable properties (dataset, datasetcollection, application)**

| Name             | Definition                          | Data type  | Property Mapping to Information Model                              |
|------------------|-------------------------------------|--|--|
| TopicCategory    | Main theme(s) of the dataset.       | CodeList, s. ISO19115:MD_TopicCategoryCode                     | MD_Metadata.identificationInfo.MD_DataIdentification.topicCategory |
| ResourceLanguage | Language(s) used within the dataset | CharacterString: ISO 639-2:2002 language codes (three letters) | MD_Metadata.identificationInfo.MD_DataIdentification.language      |

<sup>14</sup> If an instance of the class MD\_SecurityConstraint exists for a resource, the “HasSecurityConstraints” is “true”, otherwise “false”

|                            |  |   |  |
|----------------------------|--|---|--|
| GeographicDescription Code | Description of the geographic area using identifiers.  | CharacterString   | MD_Metadata.identificationInfo.MD_DataIdentification.extent.EX_Extent.geographicElement.EX_GeographicDescription.geographicIdentifier.MD_Identifier.code |
| <i>SpatialResolution</i>   | Factor which provides a general understanding of the density of spatial data in the dataset. | Spatial Resolution:one of Denominator or DistanceValue / DistanceUOM, see Table 12. |  |
| <i>TemporalExtent</i>      | Temporal extent of the resource  | TemporalExtent , see Table 13.  |  |

**Table 12 - Composition of union SpatialResolution**

| Name          | Definition   | Datatype                     | Property Mapping to Information Model  |
|---------------|--|------------------------------|--|
| Denominator   | Level of detail expressed as a scale factor or a ground distance. Here: the number below the line in a vulgar fraction.<br>Only used, if DistanceValue and DistanceUOM are not used. | Integer                      | MD_Metadata.identificationInfo.MD_DataIdentification.spatialResolution.MD_Resolution.equivalentScale.MD_RepresentativeFraction.denominator |
| DistanceValue | Sample ground distance. Here: the distance as decimal value.<br>Only used, if Denominator is not used.   | Float, sample: 12.75         | MD_Metadata.identificationInfo.MD_DataIdentification.spatialResolution.MD_Resolution.distance.gco:Distance                                 |
| DistanceUOM   | Sample ground distance. Here: the name of the unit of measure.<br>Only used, if Denominator is not used.   | CodeList, one of: meter, ... | MD_Metadata.identificationInfo.MD_DataIdentification.spatialResolution.MD_Resolution.distance.gco:Distance@uom                             |

**Table 13:Composition of union TemporalExtent**

| Name             | Definition                         | Datatype      | Property Mapping to Information Model   |
|------------------|------------------------------------|---------------|---|
| TempExtent_begin | Temporal extent information: begin | DateTime-8601 | MD_Metadata.identificationInfo.MD_DataIdentification.extent.EX_Extent.temporalElement.EX_TemporalExtent.extent.TimePeriod.beginPosition |
| TempExtent_end   | Temporal extent information: end   | DateTime-8601 | MD_Metadata.identificationInfo.MD_DataIdentification.extent.EX_Extent.temporalElement.EX_TemporalExtent.extent.TimePeriod.endPosition   |

For information resources of type ‘service’ the following additional search properties must be supported.

**Table 14 - Additional queryable properties (service)**

| Name                       | Definition  | Data type   | Property Mapping to Information Model   |
|----------------------------|---|---|---|
| ServiceType                | Name of a service type.                               | ServiceTypeID, Codelist <sup>15</sup> : “WFS”, “WMS”,...                                | MD_Metadata.identificationInfo.SV_ServiceIdentification.serviceType   |
| ServiceTypeVersion         | The version of a service type.                        | Codelist <sup>16</sup> : “1.0”, “2.0”, “1.1.1”,...                                      | MD_Metadata.identificationInfo.SV_ServiceIdentification.serviceTypeVersion  |
| Operation                  | Name of a service operation.                          | CharacterString<br>One of the available operations.<br>Example:<br>Operation = “GetMap” | MD_Metadata.identificationInfo.SV_ServiceIdentification.containsOperations.<br>SV_OperationMetadata.operationName   |
| GeographicDescription Code | Description of the geographic area using identifiers. | CharacterString   | MD_Metadata.identificationInfo.SV_ServiceIdentification.extent.EX_Extent.geographicElement.EX_GeographicDescription.geographicIdentifier.MD_Identifier.code |
| <i>OperatesOnData</i>      | Specifies the tightly coupled dataset relation        | OperatesOnData  |   |
| CouplingType               | The coupling type of this service.                    | Codelist, one of: loose, mixed, tight   | MD_Metadata.identificationInfo.SV_ServiceIdentification.couplingType.SV_CouplingType.code@codeListValue   |

**Table 15: Composition of union OperatesOnData**

| Name                 | Definition  | Data type  | Property Mapping to Information Model  |
|----------------------|---|------------|--|
| OperatesOn           | Identifier of a dataset tightly coupled with the service instance.                              | Identifier | MD_Metadata.identificationInfo.SV_ServiceIdentification.operatesOn.MD_DataIdentification.citation.CI_Citation.identifier |
| OperatesOnIdentifier | Identifier of a tightly coupled dataset on which the service operates with a specific operation | Identifier | MD_Metadata.identificationInfo.SV_ServiceIdentification.coupledResource.<br>SV_CoupledResource.identifier                |

<sup>15</sup> The official OGC mnemonics should be used

<sup>16</sup> The official OGC version numbers should be used

|                |  |                 |  |
|----------------|--|-----------------|--|
| OperatesOnName | Name of an operation with which the service operates on a tightly coupled dataset with a specific identifier | CharacterString | MD_Metadata.identificationInfo.SV_ServiceIdentification.coupledResource.SV_CoupledResource.operationName |
|----------------|--|-----------------|--|

See Annex F for examples related to tightly coupled service queries.

### 7.2.5 Additional returnable properties

The following tables define the additional returnable properties<sup>17</sup>. These elements can be returned as a result of a query. The number of elements that are returned is determined by the requested result set (elementSetName, see 7.4).

**Table 16: Additional returnable properties common to all types of resources**

| Term used in application profile | Data type                     | Property Mapping to Information Model  |
|----------------------------------|-------------------------------|--|
| ParentIdentifier                 | Identifier                    | MD_Metadata.parentIdentifier   |
| ResourceIdentifier               | Identifier                    | MD_Metadata.identificationInfo.<br>AbstractMD_Identification.citation.CI_Citation.<br>identifier                                     |
| HierarchyLevelName               | CharacterString               | MD_Metadata.hierarchyLevelName   |
| MetadataStandardName             | CharacterString               | MD_Metadata.metadataStandardName   |
| MetadataStandardVersion          | CharacterString               | MD_Metadata.metadataStandardVersion  |
| MetadataCharacterSet             | CharacterString               | MD_Metadata.characterSet.MD_ScopeCode@codeListValue  |
| GraphicOverview                  | CharacterString               | MD_Metadata.identificationInfo.AbstractMD_Identification.graphicOverview.MD_BrowseGraphic.fileName                                   |
| ReferenceSystem                  | ReferenceSystem, see Table 20 |  |
| Lineage                          | CharacterString               | MD_Metadata.dataQualityInfo.DQ_DataQuality.lineage.LI_Lineage.statement  |
| OnlineResource                   | anyURI                        | MD_Metadata.distributionInfo.MD_Distribution.transferOptions.MD_DigitalTransferOption.online.CI_OnlineResource.linkage.URL           |
| FormatVersion                    | CharacterString               | MD_Metadata.distributionInfo.MD_Distribution.distributionFormat.MD_Format.version  |
| RevisionDate                     | Date-8601                     | MD_Metadata.identificationInfo.AbstractMD_Identification.citation.CI_Citation.date.CI_Date[dateType.CI_DateTypeCode.@codeListValue=] |

<sup>17</sup> the concepts (defined as barewords, type of short-links to XPath elements used in the following section, will not directly appear in results!

|  |  |                      |
|--|--|----------------------|
|  |  | revision'].date.Date |
|--|--|----------------------|

**Table 17: Additional returnable properties for dataset**

| Term used in application profile | Data type                       | Property Mapping to Information Model   |
|----------------------------------|---------------------------------|---|
| TopicCategory                    | CharacterString                 | MD_Metadata.identificationInfo.MD_DataIdentification.topicCategory  |
| CharacterSet                     | CharacterString                 | MD_Metadata.identificationInfo.MD_DataIdentification.characterSet.MD_CharacterSetCode@codeListValue                           |
| ResourceLanguge                  | CharacterString                 | MD_Metadata.identificationInfo.MD_DataIdentification.language   |
| SpatialRepresentationType        | CharacterString                 | MD_Metadata.identificationInfo.MD_DataIdentification.spatialRepresentationType.MD_SpatialRepresentationTypeCode@codeListValue |
| SpatialResolution                | SpatialResolution, see Table 19 |   |

**Table 18: Additional returnable properties for service**

| Term used in application profile | Data type                      | Property Mapping to Information Model   |
|----------------------------------|--------------------------------|---|
| ServiceType                      | CharacterString                | MD_Metadata.identificationInfo.SV_ServiceIdentification.serviceType                                     |
| ServiceTypeVersion               | CharacterString                | MD_Metadata.identificationInfo.SV_ServiceIdentification.serviceTypeVersion                              |
| CouplingType                     | CharacterString                | MD_Metadata.identificationInfo.SV_ServiceIdentification.couplingType.SV_CouplingType.code@codeListValue |
| ServiceOperation                 | ServiceOperation, see Table 21 |   |

**Table 19 - Composition of union SpatialResolution**

| Name        | Datatype | Property Mapping to Information Model  |
|-------------|----------|--|
| Denominator | Integer  | MD_Metadata.identificationInfo.MD_DataIdentification.spatialResolution.MD_Resolution.equivalentScale.MD_RepresentativeFraction.denominator |

|               |          |  |
|---------------|----------|--|
| DistanceValue | Float    | MD_Metadata.identificationInfo.MD_DataIdentification.spatialResolution.MD_Resolution.distance.Distance     |
| DistanceUOM   | CodeList | MD_Metadata.identificationInfo.MD_DataIdentification.spatialResolution.MD_Resolution.distance.Distance@uom |

**Table 20: Composition of union ReferenceSystem**

| Term used in application profile | Data type       | Property Mapping to Information Model  |
|----------------------------------|-----------------|--|
| Code                             | CharacterString | MD_Metadata.referenceSystemInfo.MD_ReferenceSystem.referenceSystemIdentifier.RS_Identifier.code      |
| CodeSpace                        | CharacterString | MD_Metadata.referenceSystemInfo.MD_ReferenceSystem.referenceSystemIdentifier.RS_Identifier.codeSpace |
| Version                          | CharacterString | MD_Metadata.referenceSystemInfo.MD_ReferenceSystem.referenceSystemIdentifier.RS_Identifier.version   |

**Table 21: Composition of union ServiceOperation**

| Term used in application profile | Data type       | Property Mapping to Information Model  |
|----------------------------------|-----------------|--|
| Operation                        | CharacterString | MD_Metadata.identificationInfo.SV_ServiceIdentification.containsOperations.<br>SV_OperationMetadata.operationName                                  |
| DCP                              | CharacterString | MD_Metadata.identificationInfo.SV_ServiceIdentification.containsOperations.<br>SV_OperationMetadata.DCP  |
| Linkage                          | anyURI          | MD_Metadata.identificationInfo.SV_ServiceIdentification.containsOperations.<br>SV_OperationMetadata.connectPoint.<br>CI_OnlineResource.linkage.URL |

### 7.3 Supported data bindings

This section describes supported representations of each of the information objects specified in section 7.2.1. Currently, the only data binding supported is XML. Any information object that is to be managed by a catalogue service complying with this

profile must apply this presentation form. The encoding of any information object in this profile is based on ISO/TS19139 [ISO/TS19139].

Data bindings are distinguished by the value of the attribute `MD_Metadata.hierarchyLevel.MD_ScopeCode@codeListValue`. If a valid value (see below) is missing, the georesource described will be considered as “dataset” (default).

### 7.3.1 Dataset

According to the given information model, datasets shall be described by [ISO/TS19139]. No extensions to the XML encoding defined by this specification have to be made. In addition, the following rules apply to dataset XML encoding according to this profile:

To determine whether the provided metadata record is a dataset, the property `MD_Metadata.hierarchyLevel.MD_ScopeCode@codeListValue` must have the value “dataset”.

### 7.3.2 Datasetcollection

According to the given information model, a datasetcollection shall be described by [ISO/TS19139]. No extensions to the XML encoding defined by this specification have to be made. In addition, the following rules apply to datasetcollection XML encoding according to this profile:

To determine whether the provided metadata record is a datasetcollection, the property `MD_Metadata.hierarchyLevel.MD_ScopeCode@codeListValue` must have the value “series”.

### 7.3.3 Service

According to the given information model, services (tightly or loosely coupled) shall be described by the XML Schemas described in Annex D1 or D2. This schema makes use of complex types defined by [ISO/TS 19139] and shall be used in conjunction with that encoding.

The XML schema for encoding service metadata is described in Annex D1 and D2.

In addition, the following rules apply to service XML encoding according to this profile:

To determine whether the provided metadata record is a service, the property `MD_Metadata.hierarchyLevel.MD_ScopeCode@codeListValue` must have the value “service”.

### 7.3.4 Application

According to the given information model, applications shall be described by [ISO/TS19139]. No extensions to the XML encoding defined by this specification have to be made. In addition, the following rules apply to application XML encoding according to this profile:

## OGC 07-045r2

To determine whether the provided metadata record is an application, the property `MD_Metadata.hierarchyLevel.MD_ScopeCode@codeListValue` must have the value “application”.

The online resource (if provided) of an application is identified by: `MD_Metadata.distributionInfo.MD_Distribution.transferOptions.MD_DigitalTransferOptions.onLine.CI_OnlineResource.linkage.URL`

### 7.4 Result sets

This section defines the metadata elements that must be included for valid result sets of this application profile. These elements have been defined earlier in the sections 7.2.3.2 and 7.2.5. This section makes use of the metadata element names that have been mapped to specific paths.

**Table 22 - Overview AP ISO resultsets**

| <b>OutputSchema\ElementSetName</b>  | <b>brief</b>  | <b>summary</b>  | <b>full</b>     |
|---|---|---|-----------------|
| <a href="http://www.opengis.net/cat/csw/2.0.2">http://www.opengis.net/cat/csw/2.0.2</a> | +   | +   | +               |
| <a href="http://www.isotc211.org/2005/gmd">http://www.isotc211.org/2005/gmd</a>         | +   | +   | +               |
| <Namespaces of further valid ISO 19139 Profiles> (optional)                             | same as for <a href="http://www.isotc211.org/2005/gmd">http://www.isotc211.org/2005/gmd</a> | same as for <a href="http://www.isotc211.org/2005/gmd">http://www.isotc211.org/2005/gmd</a> | + <sup>18</sup> |

In addition to the mandatory output schemas defined in the table above (<http://www.opengis.net/cat/csw/2.0.2> and <http://www.isotc211.org/2005/gmd>), a catalogue service instance may define additional output schemas which must be an extended ISO 19139 schema or a specific subset of information related to ISO 19139. These additional output schemas are defined by their namespace. These namespaces must also be listed in the catalogue’s capabilities document (see 7.5), so that a client can determine what schemas are supported as output by a specific implementation.

In any case, ‘brief’, ‘summary’ and ‘full’ shall be supported also by additional output schemas, taking into account the elements related to each resultset as defined by this specification. Each of the result sets (except ‘full’, which must comply to a derived xml schema) shall comply with the ISO19139 xml schemas (not part of this document).

---

<sup>18</sup> May return an instance of the profile or the standard ISO19139 schema (e.g. if additional profile information is not available)



The elements listed in the next sections do not imply any obligation. The obligation for each element is determined by ISO 19115 and ISO 19119 respectively.

#### 7.4.1 BRIEF Resultset

A response to a valid catalogue service request with `ElementSetName=brief`. The following elements are valid returnables for a brief record.

- BoundingBox
- Identifier
- GraphicOverview
- ServiceType
- ServiceTypeVersion
- Title
- Type (HierarchyLevel)

#### 7.4.2 SUMMARY Resultset

A response to a valid catalogue service request with `ElementSetName=summary`. The elements in this resultset summarize the returnable properties that have been defined in the sections 7.2.3.2 and 7.2.5.

The following elements are valid returnables for a summary record.

- Abstract
- CharacterSet
- Creator
- Contributor
- CouplingType
- BoundingBox
- Format
- FormatVersion
- GraphicOverview
- HierarchyLevelName
- Identifier
- Language
- Lineage
- MetadataCharacterSet
- MetadataStandardName
- MetadataStandardVersion
- Modified
- OnlineResource
- ParentIdentifier
- Publisher
- ResourceIdentifier

## OGC 07-045r2

- ResourceLanguage
- ReferenceSystem
- RevisionDate
- Rights
- ServiceOperation
- ServiceType
- ServiceTypeVersion
- SpatialResolution
- SpatialRepresentationType
- Title
- TopicCategory
- Type (HierarchyLevel)

### 7.4.3 FULL Resultset

A response to a valid catalogue service request with `ElementSetName=full`. It may at a maximum contain all elements defined by [ISO/TS 19139]. For an ISO19139 extended profile it must also contain all the extensions defined herein.

## 7.5 Service information model

This section describes the content model and syntax for service metadata of a catalogue service compliant with the profile. This model is described according to [OGC 05-008c1]. A compliant catalogue service shall describe its capabilities document according to the terms defined by [OGC 05-008c1].

Because every CSW server must implement the filter predicate language as defined in [OGC 04-095], the server must include a `Filter_Capabilities` section in the service metadata to describe which elements of the predicate language are supported [OGC 07-006] (see 8.3).

The document **must** be a valid Capabilities document as defined in [OGC 07-006] (see <http://schemas.opengis.net/>).

Catalogues may advertise, in the capabilities document, operation constraints that are specific to CSW-ISO catalogues. Operation constraints are described in sub clause 7.4.5 of [OGC 05-008c1].

**EXAMPLE** The following XML fragment shows how the `IsoProfiles` constraint can be used to list the supported `Iso-Profiles`:

```
<ows:OperationsMetadata>
  .
  .
  .
  <ows:Constraint name="IsoProfiles">
    <ows:Value>http://www.isotc211.org/2005/gmd</ows:Value>
    <ows:Value>http://www.adv.de/extendedISO</ows:Value>
  </ows:Constraint>
</ows:OperationsMetadata>
```

Table 22 lists the additional operation constraints of the getRecords operation.

**Table 23 – Additional GetRecords constraints**

| Constraint name        | Content  |
|------------------------|--|
| SupportedISOQueryables | A list of the supported additional queryables defined in this profile (e.g. parentIdentifier).                               |
| AdditionalQueryables   | A list of additional queryables defined e.g. by a specific community, not defined in this profile or the base specification. |

Catalogues may advertise in the capabilities document, to what other catalogues a query is distributed to by using an operation constraint called “FederatedCatalogues” (see version 2.0.2 of the base specification). Here a federated catalogue must be listed by the URL of the HTTP/KVP/GET getCapabilities request.

Table 23 lists additional operation constraints which are common to all operations.

**Table 24 – Additional operation constraints**

| Constraint name | Content   |
|-----------------|---|
| IsoProfiles     | List of namespaces of supported iso19139 profiles. Must minimally include “ <a href="http://www.isotc211.org/2005/gmd">http://www.isotc211.org/2005/gmd</a> ”!<br>Additional iso19139 profiles (e.g. “ <a href="http://www.adv.de/extendedISO">http://www.adv.de/extendedISO</a> ”) may be included which can be queried by getRecords via outputSchema= <a href="http://www.adv.de/extendedISO">http://www.adv.de/extendedISO</a> and elementSetName=full. The profiles must be valid ISO19139 extensions. |
| XPathQueryables | If such a constraint including a value-element with the value-content ‘allowed’ is available, XPath Expressions are supported as queryables<br><pre>&lt;ows:Constraint name="XPathQueryables"&gt;   &lt;ows:Value&gt;allowed&lt;/ows:Value&gt; &lt;/ows:Constraint&gt;</pre>  |
| WSDL            | A reference to a W3C WSDL service description. See Annex C.   |

CSW servers shall indicate whether or not SOAP encodings of operation requests can be transferred using HTTP POST. This indication shall use an ows:Constraint element named PostEncoding, within the ows:OperationsMetadata section of the Capabilities document. This PostEncoding constraint shall specify the formats that can be used with HTTP POST transfer or operation requests. The value SOAP for PostEncoding shall

## OGC 07-045r2

indicate that SOAP encoded operation requests can be handled. The value XML shall indicate that (bare) XML encoded operation requests can be handled.

If the connect point URL is the same for all SOAP-encoded and base-XML operation requests, the `ows:Constraint` element shall be included in the `ows:OperationsMetadata` element. If the connect point URL is different for SOAP-encoded and base-XML operation requests, this `ows:Constraint` element shall be included in each `ows:Post` element.

### 7.6 Collaboration with catalogs based on other CSW 2.0.2 profiles

The purpose of this section is to describe how to interoperably interact with OGC CSW 2.0.2 base profile catalogs and catalogs based on other CSW 2.0.2 profiles, like eBRIM or EO-profile catalogs.

For an ISO based catalog it is possible to query a CSW 2.0.2 base profile catalog (e.g. in the case of a distributed search) and obtain useful results. This is achieved by using the CSW 2.0.2 common profile which includes the list of core queryable properties and the common record schema.

The salient feature of the common profile is the information model which declares the **csw:Record** element. The **csw:Record** element is the root element of the common profile's information model and is a container for a subset of Dublin Core metadata elements. According to the CSW 2.0.2 specification, all compliant catalogs must support a view of their information model that maps to the **record.xsd** schema. Thus, a client should be able to query any CSW 2.0.2 catalog, regardless of the underlying information model, using the elements defined in the **record.xsd** schema (see base specification).

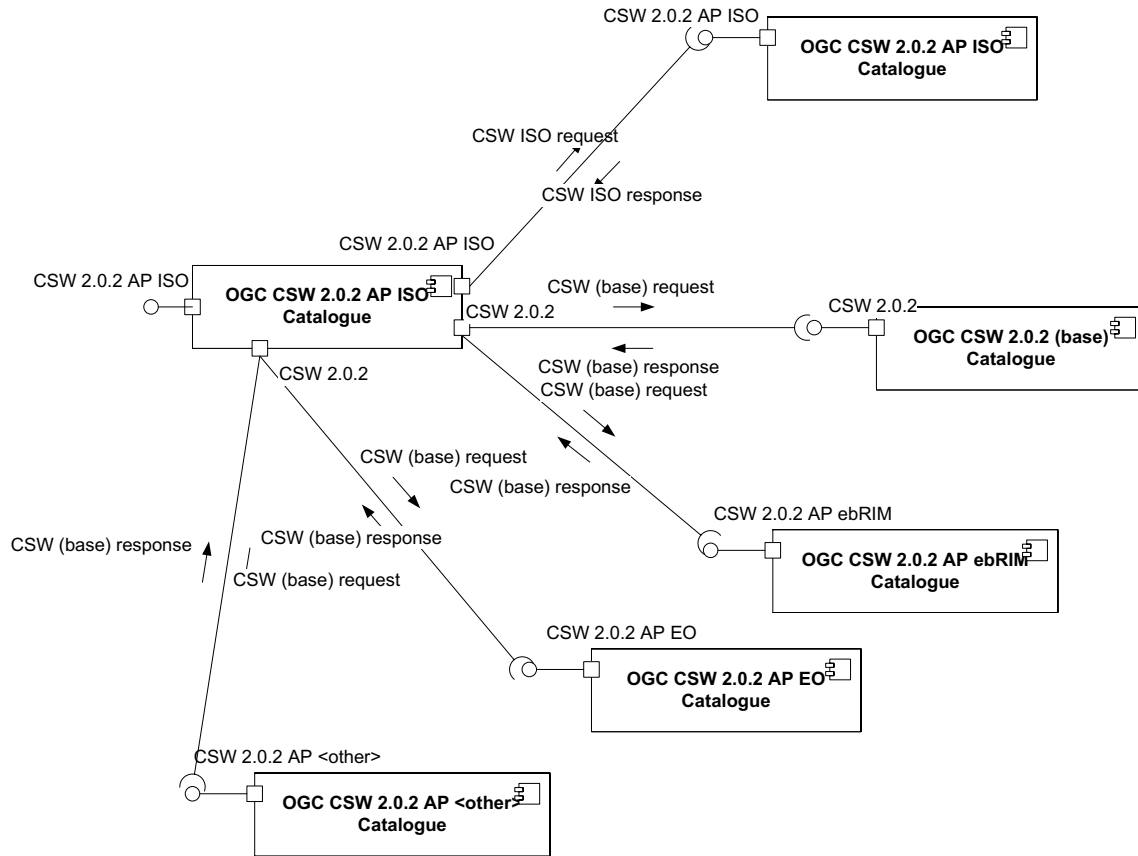

**Figure 9: Distributed Search on other base- or profile- CSW 2.0.2 catalogs**

**7.7 Native language support**

Support for multiple languages of metadata records will be realized by taking over the approach defined by ISO 19115:2003/Cor. 1:2006. Per corrigendum, an optional but repeatable attribute locale has been added to the class MD\_Metadata:

- When this attributes is not implemented, the metadata set is expected to be monolingual: the language of the metadata is defined by the language attribute of MD\_Metadata.
- When this attribute is implemented, each instance represents a locale (language, country and character encoding) in which the metadata elements may be translated. The language attribute still defines the default language of the metadata, i.e. the language in which all the metadata elements are expressed. Then each metadata element can be translated in some of the locales define for the metadata set

**8 External interfaces**

This view describes the externally visible behaviour of the system, including the interfaces provided by its components and the supported protocol bindings. It defines the request and response message structures as part of the operation signatures, primarily the

differences to that of the OGC CS 2.0.2 base specification. It also documents supported query facilities and some implementation guidance as well as a few security considerations.

### 8.1 Imported protocol binding (Relationship to the common model)

This profile imports the HTTP protocol binding from [OGC 07-006].

Table 25 shows how the operations of this profile (CSW(T) ISO) are mapped to the operations specified by the CSW 2.0.2 specification. This is a full mapping in that all of the CSW(T) ISO operations have a corresponding CSW operation.

**Table 25 - Mapping CSW(T) ISO operations to CSW operations**

| CSW operation                | CSW(T) <u>ISO</u> operation  |
|------------------------------|------------------------------|
| OGC_Service.GetCapabilities  | OGC_Service.GetCapabilities  |
| CSW-Discovery.GetRecords     | CSW Discovery.GetRecords     |
| CSW-Discovery.DescribeRecord | CSW Discovery.DescribeRecord |
| CSW-Discovery.GetDomain      | CSW Discovery.GetDomain      |
| CSW-Discovery.GetRecordById  | CSW Discovery.GetRecordById  |
| CSW-Publication.Transaction  | CSWT Manager.Transaction     |
| CSW-Publication.Harvest      | CSWT Manager.Harvest         |

Apart from the GetCapabilities operation, all operations must support the embedding of requests and responses in SOAP messages. In this case only SOAP messaging (via HTTP/POST) with document/literal style has to be used. Messages must conform to SOAP 1.2 (<http://www.w3.org/TR/SOAP/>). The message payload will be in the body of the SOAP envelope<sup>19</sup>.

Most operations support the encoding of the request messages as keyword-value pairs (KVP) within a request URI, all operations support the usage of a XML entity-body. Responses are XML-encoded.

The HTTP encoding of catalogue operation requests shall use HTTP GET with keyword-value pairs (KVP) encoding and HTTP POST with XML encoding as specified in Section 11 of [OGC 05-008c1]<sup>20,21</sup>. Note that the parameter names in all KVP encodings must be handled in a **case insensitive** manner while parameter values shall be handled in a **case**

<sup>19</sup> Further details can be found in chapter 10.3.2 of the CSW base specification

<sup>20</sup> XML = application/xml using POST (with a charset parameter if necessary—UTF-8 is strongly recommended)

<sup>21</sup> KVP = URL-encoded key/value pairs using GET or application/x-www-form-urlencoded using POST

**sensitive** manner.

Table 26 summarizes the CSW(T) ISO operations and their encoding methods that are applied in this profile. The mandatory method bindings and data encodings are printed in bold.

**Table 26 - Operation request encoding**

| <b>CSW(T) ISO Operation</b> | <b>Request encoding</b>              |
|-----------------------------|--------------------------------------|
| GetCapabilities             | XML(POST+SOAP) and <b>KVP (GET)</b>  |
| DescribeRecord              | <b>XML (POST+SOAP)</b> and KVP (GET) |
| GetDomain                   | <b>XML (POST+SOAP)</b> and KVP(GET)  |
| GetRecords                  | <b>XML (POST+SOAP)</b> and KVP(GET)  |
| GetRecordById               | <b>XML (POST+SOAP) and KVP(GET)</b>  |
| Harvest                     | <b>XML (POST+SOAP)</b> and KVP(POST) |
| Transaction                 | <b>XML (POST+SOAP)</b>               |

## 8.2 Interface specifications

This chapter describes syntax and semantics restrictions and variations of the interface operations in comparison to those of the imported CSW 2.0.2 HTTP protocol binding<sup>22</sup>. It gives formal, language-independent interface specifications (W3C WSDL) that admit multiple programming language bindings and shows error conditions that can occur.

### 8.2.1 OGC\_Service Interface

#### 8.2.1.1 GetCapabilities Operation

The GetCapabilities operation allows clients to retrieve service metadata from a server.

The GetCapabilities operation request is defined in Subclause 7.2 of the *OGC Web Services Common Specification 1.0* [OGC 05-008C1]. The column **ISO Metadata Profile** in table 26 shows syntax and/or semantics restrictions or variations of some parameters in comparison to those of the base specification. Note that all parameter names in the KVP-encoded request must be treated in a case insensitive manner, and the query component of the Request-URI in the GET request must be appropriately escaped.

<sup>22</sup> Further details can be found in the OGC Catalog Services Specification [OGC 07-006].and the OGC Web Services Common Specification [OGC 05-008]

## OGC 07-045r2

The response to a GetCapabilities request should be an XML document containing service metadata about the server [OGC 05-008C1, and OGC 07-006]. See also section 7.5 for the content of the response document.

**Table 27 – Some Parameters in GetCapabilities operation request**

| Name    | Definition              | Data type and value   | Multiplicity and use | ISO Metadata Profile |
|---------|-------------------------|---|----------------------|----------------------|
| SERVICE | Service type identifier | Character String type, not empty<br>Value is OWS type abbreviation (e.g., “CSW”, “WFS”) | One (mandatory)      | “CSW”                |
| REQUEST | Operation name          | Character String type, not empty<br>Value is operation name (e.g., “GetCapabilities”)   | GetCapabilities      | GetCapabilities      |

The value of the *service* parameter must be “CSW”. The request / response sequence of a "handshake" between a CSW AP ISO client and a CSW server and a following operation call (getRecords) is as follows (see also figure 9): the client first asks the CSW server for the capabilities (with service = "CSW"). In the capabilities document the serviceType must be set to "CSW". If the ‘operations constraint’ ‘IsoProfiles’ (see 7.5) is included in the Capabilities document the CSW server is identified as an ISO profile server.

In the following operation call (e.g. a getRecords calls) the service attribute must also be set to "CSW". The AP ISO server can now be queried in the AP ISO mode, which includes the usage of the specific ISO typeNames, queryables and outputSchemas. If the server could only be identified as an OGC Core server it can be queried only in the Core mode which includes the usage only of the Core typeName, queryables and outputSchema.



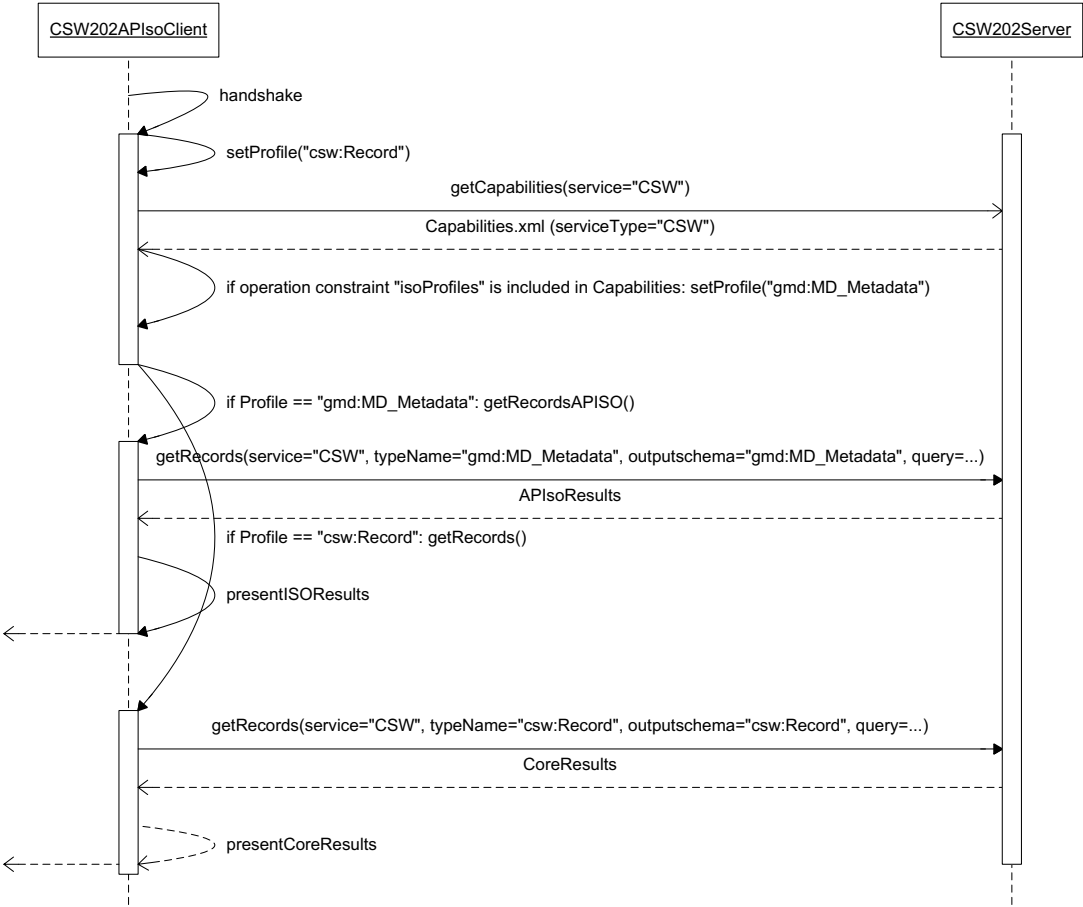

**Figure 10: Schematic profile dependant getRecords call (profile determined by handshake)**

The *sections* parameter may be used to request a subset of the complete capabilities document; the value is a comma-separated list of section names. Valid set of section names recognized by this profile are listed in Table 28. If this parameter is absent, the complete description must be returned; unrecognized section names are ignored.

**Table 28 – Permissible section names**

| Section name          | Content  |
|-----------------------|--|
| ServiceIdentification | General information about the service (type, version, etc.). |

|                     |  |
|---------------------|--|
| ServiceProvider     | Information about the organization providing the service.  |
| OperationsMetadata  | Summarizes the operational characteristics of the service. |
| Filter_Capabilities | Describes supported OGC filter operators                   |

The WSDL portType component of the OGC\_Service interface is shown in Listing 1; this is a fragment of the complete WSDL 2.0 definition for the CSW Catalogue capability class (Annex C).

**Listing 1 - OGC\_Service: WSDL interface definition**

```
<wsdl:portType name="csw">
  <wsdl:operation name="csw.getCapabilities">
    <wsdl:input message="csw-req:GetCapabilitiesRequest"/>
    <wsdl:output message="csw-resp:GetCapabilitiesResponse"/>
    <wsdl:fault name="ServiceExceptionReport" message="csw-
resp:ServiceExceptionReport"/>
  </wsdl:operation>
```

## 8.2.2 CSW Discovery Interface

### 8.2.2.1 GetRecords Operation

In [OGC 07-006] two general model operations (**search** and **present**) are combined in the form of the **GetRecords** operation, which does a search and a piggybacked present (Subclause 10.8 of OGC 07-006).

#### 8.2.2.1.1 Request

Table 29 specifies the parameters of the **GetRecords** operation request (KVP). The column **ISO Metadata Profile** shows syntax and/or semantics restrictions or variations in comparison to those of the base specification. The encoding in the table is directly suitable for the HTTP GET/KVP binding<sup>23</sup>.

---

<sup>23</sup> If Content-Type of request is XML, then the document element must be the <csw:GetRecords> element, as defined in the following CSW xml schema: CSW-discovery.xsd

Table 29 - Parameters in GetRecords operation request

| Keyword                 | Datatype & Value  | Optionality  | ISO Metadata Profile   |
|-------------------------|---|--|--|
| REQUEST                 | Character String.<br>Fixed value of “GetRecords”. (The value is case insensitive.)  | Mandatory  | Mandatory  |
| SERVICE                 | Character String.   | Mandatory<br>Fixed value of “CSW” <sup>24</sup>  | Mandatory<br>Fixed value of “CSW”  |
| VERSION                 | Character String.<br>Fixed value of “2.0.2”   | Mandatory  | Mandatory  |
| NAMESPACE <sup>25</sup> | List of Character String, comma separated<br><br>Used to specify a namespace and its prefix<br><br>Format must be xmlns([prefix=]namespace-url). If the prefix is not specified then this is the default namespace. | Include value for each distinct namespace used by all qualified names in the request.<br><br>If not included, all qualified names are in default namespace | Include value for each distinct namespace used by all qualified names in the request.<br><br>If not included, all qualified names are in default namespace |

---

<sup>25</sup> The NAMESPACE parameter contains the same information as the xmlns attributes which may be used for encoding namespace information in XML encoding.

| Keyword      | Datatype & Value  | Optionality   | ISO Metadata Profile  |
|--------------|---|---|---|
| RESULTTYPE   | CodeList.<br>One of “hits”, “results” or “validate”.  | Optional.<br>Default value is “hits”.                                     | Optional.<br>Default value is “hits”.<br>Indicate whether the catalogue returns the full result set (if ELEMENTSET NAME or ELEMENTNAME are missing) or just the number of hits the query found. If the value is “hits”, ELEMENTSET NAME or ELEMENTNAME are ignored. |
| REQUESTID    | URI   | Zero or one (Optional)<br>Include when client chooses to assign requestId | Zero or one (Optional)<br>Include when client chooses to assign requestId   |
| OUTPUTFORMAT | Character String<br>Value is Mime type<br>The only value that is required to be supported is “application/xml”.<br>Other supported values may include “text/xml”, “text/html” and “text/plain”. | Optional.<br>Default value is “application/xml”.                          | Optional.<br>Default value is “application/xml” <sup>26</sup> .   |

---

<sup>26</sup> The list of output formats that a CSW instance provides must be advertised in the Capabilities document.W3C: Authors should also be aware of the difference between 'application/xml' and 'text/xml' with regard to the treatment of

| Keyword       | Datatype & Value  | Optionality  | ISO Metadata Profile   |
|---------------|---|--|--|
| OUTPUTSCHEMA  | Any URI.<br><br>Indicates which schema shall be used to generate the response.  | Optional<br>Default value is <i>http://www.opengis.net/cat/csw/2.0.2</i> . | Optional<br>If available, it must support <i>http://www.opengis.net/cat/csw/2.0.2</i> and " <i>http://www.iso.org/2005/gmd</i> ". Default value is <i>http://www.opengis.net/cat/csw/2.0.2</i> . |
| STARTPOSITION | Non-zero, positive Integer  | Optional<br>The default value is 1.  | Optional<br>The default value is 1.  |
| MAXRECORDS    | PositiveInteger   | Optional<br>The default value is 10.                                       | Optional<br>The default value is 10.   |
| TYPENAMES     | List of Character String, comma separated<br><br>Used to specify which entities, from the information model of the catalogue, shall be queried. | Mandatory  | Mandatory:<br>Must support <u>one of</u> "csw:Record" or "gmd:MD_Metadata" in a query. Default value is "csw:Record".  |

---

character encoding. According to "3.1 Text/xml Registration" of [RFC3023], if a text/xml entity is received with the charset parameter omitted, MIME processors and XML processors MUST use the default charset value of "us-ascii"[ASCII]. This default value is authoritative over the encoding information specified in the XML declaration, or the XML default encodings of UTF-8 and UTF-16 when no encoding declaration is supplied, so omitting the charset parameter of a 'text/xml' entity might cause an unexpected result. As mentioned in [RFC3023], the use of the charset parameter is STRONGLY RECOMMENDED.

| Keyword   | Datatype & Value  | Optionality  | ISO Metadata Profile  |
|---|---|--|---|
| ELEMENTSETNAME <sup>27</sup><br>or<br>ELEMENTNAME | List of Character String<br><br>The ElementName or (mutually exclusive) ElementSetName parameter is used to specify which properties of the outputSchema to include in each record in the response.   | Optional<br>Default action is to present all metadata elements.  | Optional<br>Valid values are: brief, summary, full.<br>Default value is “summary”.<br>Usage of the ELEMENTNAME is not further specified here. |
| CONSTRAINTLANGUAGE                                | CodeList<br>One of “CQL_TEXT” or “FILTER”   | Must be specified with QUERYCONSTRAINT parameter.                | Must be specified with QUERYCONSTRAINT parameter.   |
| CONSTRAINT_LANGUAGE_VERSION                       | String<br>May be used to specify a version number indicating which version of a specification the constraint conforms to. For example, if “FILTER” is being used, this parameter could be set to “1.1.0” indicating that the filter conforms to version 1.1.0 of the Filter Encoding Implementation Specification [OGC 02-059]. | Mandatory  | Mandatory   |
| CONSTRAINT  | String<br>The predicate expression specified in the language indicated by the CONSTRAINTLANGUAGE parameter.   | Optional<br>Default action is to execute an unconstrained query. | Optional<br>Default action is to execute an unconstrained query.  |

---

<sup>27</sup> Because for this application profile it is not possible that a query includes more than one typename, any value(s) of the typeName attribute of the elementSetName element are ignored.

| Keyword           | Datatype & Value  | Optionality   | ISO Metadata Profile  |
|-------------------|---|---|---|
| SORTBY            | <p>List of Character String, comma separated</p> <p>Ordered list of names of metadata elements to use for sorting the response</p> <p>Format of each list item is <i>metadata_element_name:A</i> indicating an ascending sort or <i>metadata_element_name:D</i> indicating descending sort<sup>28</sup>.</p> <p><i>metadata_element_name</i>: use only the plain name (not case sensitive) without any prefixes etc, because these are uniquely defined.</p> <p>Example: Denominator instead of SpatialResolution.Denominator</p> | <p>Optional</p> <p>Default action is to present the records in the order in which they are retrieved.</p> | <p>Optional</p> <p>Default action is to present the records in the order in which they are retrieved.</p> |
| DISTRIBUTEDSEARCH | Boolean   | <p>Optional</p> <p>Default value is FALSE.</p>  | <p>Optional</p> <p>Default value is FALSE.</p>  |
| HOPCOUNT          | Integer   | <p>May be specified only if DISTRIBUTEDSEARCH is specified. If not specified, the default value is 2.</p> | <p>May be specified only if DISTRIBUTEDSEARCH is specified. If not specified, the default is 2.</p>       |

<sup>28</sup> this is valid for KVP encoding, for XML please look into the XML schemas

| Keyword         | Datatype & Value | Optionality  | ISO Metadata Profile  |
|-----------------|------------------|--|---|
| RESPONSEHANDLER | Any URI          | Zero or one (Optional)<br>If not included, process request synchronously | asynchronous processing not supported. If the <csw:ResponseHandler> element is included it shall be ignored and the request will be processed in the normal synchronous fashion |

If a catalogue record is associated with a null-value for queryable X then this records does not fulfill any query constraint on that queryable X except “is Null”.

If typeName equals to “csw:Record” no ISO metadata profile specific queryables must be used. The handling of the queryables is as defined as in chapter 10.8.4.11 of [OGC 07-006].

If the typeNames attribute of a query equals to ‘gmd:MD\_Metadata’ (‘gmd’ representing the ‘http://www.isotc211.org/2005/gmd’ namespace) any queryable that is part of the associated filter must be represented by a qualified name with a prefix (e.g. ‘apiso’), representing the ‘http://www.opengis.net/cat/csw/apiso/1.0’ namespace. This is true for both application profile queryables as well as for the OGC common core queryables (which are mapped to the gmd metadata schema then).

Case sensitivity is as follows: For the common queryables use the same case as defined in the base specification (e.g. ‘apiso:title’), for the additional queryables use the cases as defined in this profile (tables 9-14), e.g. ‘apiso:RevisionDate’.

The support of Xpath expressions as queryables (e.g. /gmd:MD\_Metadata/gmd:fileIdentifier/gco:CharacterString) is optionally supported (see 7.5).

Examples for GetRecords requests are described in Annex G.

#### 8.2.2.1.2 Response

This operation must respond with an XML document including the results. If the **resultType** parameter is set to “results”, the catalogue service must include any matching records within the <SearchResults> element, up to the maximum number of records specified in the request. The <**SearchResults**> element is a generic XML container. This



generic container is defined by [OGC 07-006]. The content of the <SearchResults> element is the set of records returned by the **GetRecords** operation. The following XML schema fragment defines the **SearchResultsType**:

### Listing 2 - SearchResultType definition

```
<xsd:complexType name="SearchResultsType" id="SearchResultsType">
  <xsd:sequence>
    <xsd:choice>
      <xsd:element ref="csw:AbstractRecord"
        minOccurs="0" maxOccurs="unbounded"/>
      <xsd:any processContents="strict" namespace="##other"
        minOccurs="0" maxOccurs="unbounded"/>
    </xsd:choice>
  </xsd:sequence>
  <xsd:attribute name="resultSetId"
    type="xsd:anyURI" use="optional"/>
  <xsd:attribute name="elementSet"
    type="csw:ElementSetType" use="optional"/>
  <xsd:attribute name="recordSchema"
    type="xsd:anyURI" use="optional"/>
  <xsd:attribute name="numberOfRecordsMatched"
    type="xsd:nonNegativeInteger" use="required"/>
  <xsd:attribute name="numberOfRecordsReturned"
    type="xsd:nonNegativeInteger" use="required"/>
  <xsd:attribute name="nextRecord"
    type="xsd:nonNegativeInteger" use="optional"/>
  <xsd:attribute name="expires" type="xsd:dateTime" use="optional"/>
</xsd:complexType>
```

Catalogue services implementing this application profile **MUST NOT** substitute <csw:AbstractRecord> but rather <xsd:any> with XML documents that comply with one of the schemas defined in Annex D1<sup>29</sup>.

An example for a GetRecords response is described in Annex G.

On top of that, the following limitations are applied:

- This profile does not consider asynchronous processing. If the <csw:ResponseHandler> element is included it shall be ignored and the request will be processed in the normal synchronous fashion; the final response message will be returned directly to the user agent in the usual manner.
- If the client asks for the common CSW record syntax, the catalogue must return the records in one of the schemas defined in record.xsd (see [OGC 07-006]). The common CSW record syntax is an XML-based encoding of Dublin Core metadata terms; it encompasses the core metadata properties.
- If the **resultType** parameter is set to “hits”, the catalogue service shall return a <GetRecordsResponse> element containing an empty <SearchResults> element

---

<sup>29</sup> if outputSchema “<http://www.isotc211.org/2005/gmd>” is applied.

## OGC 07-045r2

that indicates the estimated size of the result set. Optional attributes may or may not be set accordingly.

- If the **resultType** parameter is set to “validate”, the catalogue service must validate the request and return an <Acknowledgement> message if validation succeeds; a <ServiceExceptionReport> is returned if validation fails.

### 8.2.2.2 GetRecordById Operation

The mandatory **GetRecordById** request retrieves a representation (per default the default representation) of one or more specific catalogue records using their identifier(s) (which is mapped to the fileidentifier of an ISO19139 document). The **GetRecordById** operation is an implementation of the **Present** operation from the general model. Normally this operation presumes that a previous query has been performed in order to obtain the identifiers that may be used with this operation.

#### 8.2.2.2.1 Request

Table 30 specifies the parameters of the GetRecordById operation request (KVP and XML). The column **ISO Metadata Profile** shows syntax and/or semantics restrictions or variations in comparison to those of the base spec. The encoding in the table is directly suitable for the HTTP GET/KVP binding.

The XML encoding of a valid request is specified in the HTTP binding of OGC 07-006. Please refer to this section to determine the appropriate XML schema.

**Table 30 - Parameters in GetRecordById operation request**

| Keyword        | Datatype & Value  | Optionality   | ISO Metadata Profile  |
|----------------|---|---|---|
| REQUEST        | Character String.<br>Fixed value of “GetRecordById”. (The value is case insensitive.) | Mandatory   | Mandatory   |
| SERVICE        | Character String.<br>Fixed value of “CSW”   | Mandatory   | Mandatory<br>Fixed value of “CSW”   |
| VERSION        | Character String.<br>Fixed value of “2.0.2”   | Mandatory   | Mandatory   |
| ELEMENTSETNAME | CodeList with allowed values:<br>“brief”, “summary” or “full”                         | Zero or one (Optional)<br>Default value is “summary”. | Zero or one (Optional)<br>Valid values are: brief, summary, full<br>Default value is: summary |

| Keyword      | Datatype & Value   | Optionality                                      | ISO Metadata Profile  |
|--------------|--|--|---|
| ID           | Comma separated list of anyURI   | One (Mandatory)                                  | One (Mandatory) identifier  |
| OUTPUTFORMAT | Character String<br>Value is Mime type<br>The only value that must be supported is "application/xml". Other supported values may include "text/xml", "text/html" and "text/plain". | Optional.<br>Default value is "application/xml". | Optional.<br>Default value is "application/xml".  |
| OUTPUTSCHEMA | URI - for reference to the preferred schema of the response  |  | Optional<br>Must support <i>http://www.opengis.net/cat/csw/2.0.2</i> and " <i>http://www.iso.org/2005/gmd</i> ". Default value is <i>http://www.opengis.net/cat/csw/2.0.2</i> . |

An example for a GetRecordById request is described in Annex G.

#### 8.2.2.2.2 Response

The following XML-Schema fragment defines the **GetRecordByIdResponseType** as part of this XML schema. This is simply the list of requested records:

#### Listing 3 - GetRecordByIdResponseType definition

```
<xsd:complexType name="GetRecordByIdResponseType"/>
  <xsd:sequence>
    <xsd:choice>
      <xsd:element ref="csw:AbstractRecord"
        minOccurs="0" maxOccurs="unbounded">
        <xsd:any processContents="strict" namespace="##other"
          minOccurs="0" maxOccurs="unbounded"/>
      </xsd:element>
    </xsd:choice>
  </xsd:sequence>
```

```
</xsd:sequence>
</xsd:complexType>
```

### 8.2.2.3 DescribeRecord Operation

The DescribeRecord operation allows a client to discover elements of the information model supported by the target catalogue service.

#### 8.2.2.3.1 Request

Table 31 specifies the parameters for the **DescribeRecord** operation request. The column **ISO Metadata Profile** shows syntax and/or semantics restrictions or variations in comparison to that of the base spec. The encoding in the table is directly suitable for the HTTP GET binding.

The XML encoding of the frame of a valid response is specified in the HTTP binding of [OGC 07-006]. Please refer to this section to determine the according XML schema.

**Table 31 - Parameters in DescribeRecord operation request**

| Keyword   | Datatype & Value  | Optionality  | ISO Metadata Profile              |
|-----------|---|--|-----------------------------------|
| REQUEST   | Character String.<br>Fixed value of “DescribeRecord”. The value is case insensitive.  | Mandatory  | Mandatory                         |
| SERVICE   | Character String.<br>Fixed value of “CSW”   | Mandatory  | Mandatory<br>Fixed value of “CSW” |
| VERSION   | Character String.<br>Fixed value of “2.0.2”   | Mandatory  | Mandatory                         |
| NAMESPACE | List of Character String, comma separated.<br><br>Used to specify a namespace and its prefix.<br>Format is xmlns([prefix=]namespace-url). If prefix is not specified, then this is the default namespace. | One (Optional) <sup>30</sup> .<br><br>Include declarations for each namespace used in a TypeName | Optional                          |

<sup>30</sup> The NAMESPACE parameter contains the same information as the xmlns attributes which may be used to define and bind namespaces in XML encoding.

| Keyword        | Datatype & Value  | Optionality   | ISO Metadata Profile                             |
|----------------|---|---|--|
| TYPENAME       | List of Character String, comma separated<br>One or more qualified type names to be described | Zero or one (Optional)<br>Default action is to describe all types known to server | Optional.<br>Must support “gmd:MD_Metadata”.     |
| OUTPUTFORMAT   | Character String<br>A MIME type indicating the format that the output document should have    | Optional.<br>Default value is “application/xml”.                                  | Optional.<br>Default value is “application/xml”. |
| SCHEMALANGUAGE | Character String  | Zero or one (Optional)<br>Default value is XMLSCHEMA                              | Only XMLSCHEMA (default) is supported            |

An example for a DescribeRecord request is described in Annex G.

#### 8.2.2.3.2 Response

The **<DescribeRecordResponse>** element (see [OGC 07-006]) is the container for the **<SchemaComponent>** element, which contains the description in the requested schema language:

```
<xsd:element name="DescribeRecordResponse" id="DescribeRecordResponse"
  type="csw:DescribeRecordResponseType"/>
<xsd:complexType name="DescribeRecordResponseType"
  id="DescribeRecordResponseType">
  <xsd:sequence>
    <xsd:element name="SchemaComponent" type="csw:SchemaComponentType"
      minOccurs="0" maxOccurs="unbounded"/>
  </xsd:sequence>
</xsd:complexType>
<xsd:complexType name="SchemaComponentType" mixed="true"
  id="SchemaComponentType">
  <xsd:sequence>
    <xsd:any namespace="##any" processContents="lax"/>
  </xsd:sequence>
  <xsd:attribute name="targetNamespace" type="xsd:anyURI" use="required"/>
  <xsd:attribute name="parentSchema" type="xsd:anyURI" use="optional"/>
  <xsd:attribute name="schemaLanguage" type="xsd:anyURI" use="required"/>
</xsd:complexType>
```

The DescribeRecordResponse must include two “SchemaComponent” elements:

- The first element contains the schema for the ISO19115/19139 data identification definition (‘identification.xsd’)
- The second element contains the schema for the ISO19119 service identification definition (‘serviceMetadata.xsd ’)

The parentSchema is a reference to the base schema (gmd.xsd).

#### 8.2.2.4 GetDomain Operation

The optional **GetDomain** operation is used to obtain runtime information about the range of values of a **metadata record element** or **request parameter**. The runtime range of values for a property or request parameter is typically much smaller than the value space for that property or parameter based on its static type definition.

This type of runtime information is useful for generating user interfaces with meaningful pick lists or for generating query predicates that have a higher chance of actually identifying a result set.

It is entirely possible that a catalogue may not be able to determine anything about the values of a property or request parameter beyond the basic type; in this case only a type reference or a type description will be returned.

##### 8.2.2.4.1 Request

Table 32 specifies the parameters for the **GetDomain** operation request. The column **ISO Metadata Profile** shows syntax and/or semantics restrictions or variations in comparison to those of the base spec. The encoding in the table is directly suitable for the HTTP GET binding.

The XML encoding of a valid response is specified in the HTTP binding of [OGC 07-006]. Please refer to this section to determine the according XML schema.

**Table 32 - Parameters in GetDomain operation request**

| Keyword | Datatype & Value  | Optionality | ISO Metadata Profile              |
|---------|---|-------------|-----------------------------------|
| REQUEST | Character String.<br>Fixed value of "GetDomain". The value is case insensitive. | Mandatory   | Mandatory                         |
| SERVICE | Character String.<br>Fixed value of "CSW"                                       | Mandatory   | Mandatory<br>Fixed value of "CSW" |
| VERSION | Character String.<br>Fixed value of "2.0.2"                                     | Mandatory   | Mandatory                         |

| Keyword       | Datatype & Value   | Optionality  | ISO Metadata Profile   |
|---------------|--|--|--|
| PARAMETERNAME | List of Character String, comma separated<br>Unordered list of names of an interface parameter, of the form<br><i>OperationName.ParameterName</i>  | Zero or one (Conditional)<br>Include when PropertyName not included  | <b>Is not supported by this profile.</b>   |
| PROPERTYNAME  | List of Character String, comma separated.<br>Unordered list of names of requested properties. In case of the search properties (defined in the information model), use only the plain names (case sensitive) without any prefixes etc, because these are uniquely defined.<br>Example: Denominator instead of SpatialResolution.Denominator | Zero or one (Conditional)<br>Include when ParameterName not included | Mandatory<br><br>(Must be included by this profile, as PARAMETERNAME is not supported) |

#### 8.2.2.4.2 Response

The response is composed of one or more <DomainValues> elements (see [OGC 07-006]). The domain values may be a list of enumerated values (i.e. <ListOfValues>), one or more ranges of values (i.e. <RangeOfValues>), or a reference to some authoritative vocabulary (i.e. <ConceptualSchema>). An example of an authoritative vocabulary might be a standard list of animal and plant species names.

If the only child element of the <DomainValue> element is the <PropertyName> or <ParameterName> element, this shall be taken to mean that the catalogue was unable to determine anything about the specified property or parameter.

The XML encoding of a valid response is specified in the HTTP binding of [OGC 07-006]. Please refer to this section to determine the appropriate XML schema.

### 8.2.3 CSWT Manager Interface

The Manager Interface defines operations for creating, modifying and deleting catalogue records. This can either be done by a 'push' mechanism, the **Transaction** operation, or a 'pull' mechanism, implemented by the **Harvest** operation.

#### 8.2.3.1 Transaction Operation

This is the 'push' mechanism, for creating, modifying and deleting catalogue records.

##### 8.2.3.1.1 Request

In the following tables, the parameters for the **Transaction** operation request are specified.

There is **no KVP encoding** for transaction operation request, because there is no convenient way of encoding the transaction payloads using keyword-value pairs. Although only XML is supported, the parameters are presented in tabular form to give a better overview.

The XML encoding of a valid response is specified in the HTTP binding of [OGC 07-006]. Please refer to this section to determine the appropriate XML schema.

Table 33 specifies only the base parameters. The <Transaction> element here defines an atomic unit of work and is a container for one or more insert, update and/or delete actions which are defined in the following tables.

**Table 33 - Parameters in Transaction operation request**

| <b>Keyword</b> | <b>Datatype &amp; Value</b>  | <b>Optionality</b> | <b>ISO Metadata Profile</b>       |
|----------------|--|--------------------|-----------------------------------|
| REQUEST        | Character String.<br>Fixed value of "Transaction". The value is case insensitive.  | Mandatory          | Mandatory                         |
| SERVICE        | Character String.<br>Fixed value of "CSW"  | Mandatory          | Mandatory<br>Fixed value of "CSW" |
| VERSION        | Character String.<br>Fixed value of "2.0.2"  | Mandatory          | Mandatory                         |
| TRANSACTION    | Defines an atomic unit of work and is a container for one or more insert, update and/or delete actions, defined in Table 34. | One or more        | One or more                       |



Table 34 specifies the parameters which are valid for every insert, update and delete operation.

**Table 34 - Parameters of Insert-, Update-, Delete-Operation**

| <b>Keyword</b>  | <b>Datatype &amp; Value</b>   | <b>Optionality</b>       | <b>ISO Metadata Profile</b> |
|-----------------|---|--------------------------|-----------------------------|
| TRANSACTIONTYPE | CodeList<br>One of “Insert”,<br>“Update”, “Delete”  | Mandatory                | Mandatory                   |
| REQUESTID       | May be used by a client application to associate a user-defined identifier with the operation.  | Zero or one              | Zero or one                 |
| VERBOSERESPONSE | May be used by a client to indicate to a server the amount of detail to generate in the response. A value of FALSE means that a CSW should generate a terse or brief transaction response. A value of TRUE means that the normal detailed transaction response should be generated. | Boolean, default “FALSE” | Boolean, default “FALSE”    |

Table 35 specifies the parameters which are valid for an insert-operation. The <Insert> element is a container for one or more records that are to be inserted into the catalogue. The schema of the record(s) must conform to the schema of the information model described using the DescribeRecord operation.

**Table 35 - Parameters of Insert-Operation**

| <b>Keyword</b> | <b>Datatype &amp; Value</b>   | <b>Optionality</b>     | <b>ISO Metadata Profile</b> |
|----------------|---|------------------------|-----------------------------|
| MD_METADATA    | Record(s) that conform to the schema of the information model described using the DescribeRecord operation. | Mandatory, one or more | Mandatory, one or more      |

| Keyword | Datatype & Value  | Optionality | ISO Metadata Profile |
|---------|---|-------------|----------------------|
| HANDLE  | Used to associate a mnemonic name for the purpose of error handling (ID). | Zero or one | Zero or one          |

Table 36 specifies the parameters which are valid for an **update**-operation. If a complete record instance value (substituting for the `<xsd:any>` element in xml) is specified then the entire record in the catalogue shall be replaced by the value of MD\_METADATA. If individual record property values are specified in MD\_METADATA, using the `<RecordProperty>` element, then those individual property values of the catalogue record shall be updated.

The `<RecordProperty>` element contains a `<Name>` element and a `<Value>` element. The `<Name>` element is used to specify the name of the record property to be updated. The value of the `<Name>` element may be a path expression to identify complex properties. The `<Value>` element contains the value that will be used to update the record in the catalogue.

**Table 36 - Parameters of Update-Operation**

| Keyword     | Datatype & Value   | Optionality | ISO Metadata Profile |
|-------------|--|-------------|----------------------|
| MD_METADATA | Accepts a complete record instance OR a list of one or more property names with their replacement values <sup>31</sup> | Mandatory   | Mandatory            |

---

<sup>31</sup> The name element is used to specify the name of the record property to be updated. The value of it may be a path expression to identify complex properties. The value element contains the value that will be used to update the record in the catalogue.

| Keyword                     | Datatype & Value  | Optionality                                       | ISO Metadata Profile                              |
|-----------------------------|---|---|---|
| TYPENAME                    | Character String  | Zero or one                                       | Zero or “gmd:MD_Metadata”. <sup>32</sup>          |
| CONSTRAINTLANGUAGE          | CodeList<br>One of “CQL_TEXT” or “FILTER”   | Must be specified with QUERYCONSTRAINT parameter. | Must be specified with QUERYCONSTRAINT parameter. |
| CONSTRAINT_LANGUAGE_VERSION | String<br>May be used to specify a version number indicating which version of a specification the constraint conforms to. For example, if “FILTER” is being used, this parameter could be set to “1.1.0” indicating that the filter conforms to version 1.1.0 of the Filter Encoding Implementation Specification [OGC 02-059]. | Mandatory   | Mandatory   |
| CONSTRAINT                  | String<br>The predicate expression specified in the language indicated by the CONSTRAINTLANGUAGE parameter.   | Mandatory.  | Mandatory   |
| HANDLE                      | Used to associate a mnemonic name for the purpose of error handling (ID).   | Zero or one                                       | Zero or one                                       |

Table 37 specifies the parameters which are valid for a delete-operation. All record instances will be deleted which are affected by the constraint.

<sup>32</sup> Profiles of this must be detected by the server.

Table 37 - Parameters of Delete-Operation

| Keyword                     | Datatype & Value  | Optionality                                       | ISO Metadata Profile                              |
|-----------------------------|---|---|---|
| CONSTRAINTLANGUAGE          | CodeList<br>One of “CQL_TEXT” or “FILTER”   | Must be specified with QUERYCONSTRAINT parameter. | Must be specified with QUERYCONSTRAINT parameter. |
| CONSTRAINT_LANGUAGE_VERSION | String<br>May be used to specify a version number indicating which version of a specification the constraint conforms to. For example, if “FILTER” is being used, this parameter could be set to “1.1.0” indicating that the filter conforms to version 1.1.0 of the Filter Encoding Implementation Specification [OGC 02-059]. | Mandatory   | Mandatory   |
| CONSTRAINT                  | String<br>The predicate expression specified in the language indicated by the CONSTRAINTLANGUAGE parameter.   | Mandatory.  | Mandatory   |
| TYPENAME                    | Character String  | Zero or one                                       | Zero or “gmd:MD_Metadata”. <sup>33</sup>          |
| HANDLE                      | Used to associate a mnemonic name for the purpose of error handling (ID).   | Zero or one                                       | Zero or one                                       |

<sup>33</sup> Profiles of this must be detected by the server.

### 8.2.3.1.2 Response

The transaction response message conveys two pieces of information. First of all, it reports a summary of the transaction by indicating the number of records created, updated or deleted by the transaction. Secondly, the transaction response message indicates the results of each insert operation found in the transaction in the form of the **<InsertResult>** element.

The **<InsertResult>** element may appear zero or more times in the transaction response. It is used to report to the client a brief representation of each new record, including the record identifier, created in the catalogue. The records must be reported in the same order in which the **<Insert>** elements appear in a transaction request and must map 1 to 1. Optionally, the handle attribute may be used to correlate a particular **<Insert>** element in the Transaction request with an **<InsertResult>** element found in the transaction response.

The following schema fragment from [OGC 07-006] shows the structure of a corresponding response.

#### Listing 4 - TransactionResponse definition

```
<xsd:element name="TransactionResponse" type="csw:TransactionResponseType"
  id="TransactionResponse"/>
<xsd:complexType name="TransactionResponseType">
  <xsd:sequence>
    <xsd:element name="TransactionSummary"
      type="csw:TransactionSummaryType"/>
    <xsd:element name="InsertResult" type="csw:InsertResultType"
      minOccurs="0" maxOccurs="unbounded"/>
  </xsd:sequence>
  <xsd:attribute name="version" type="xsd:string" use="optional"/>
</xsd:complexType>
<xsd:complexType name="TransactionSummaryType" id="TransactionSummaryType">
  </xsd:annotation>
  <xsd:sequence>
    <xsd:element name="totalInserted" type="xsd:nonNegativeInteger"
      minOccurs="0"/>
    <xsd:element name="totalUpdated" type="xsd:nonNegativeInteger"
      minOccurs="0"/>
    <xsd:element name="totalDeleted" type="xsd:nonNegativeInteger"
      minOccurs="0"/>
  </xsd:sequence>
  <xsd:attribute name="requestId" type="xsd:anyURI" use="optional"/>
</xsd:complexType>
<xsd:complexType name="InsertResultType" id="InsertResultType">
  <xsd:sequence>
    <xsd:element ref="csw:BriefRecord" maxOccurs="unbounded"/>
  </xsd:sequence>
  <xsd:attribute name="handleRef" type="xsd:anyURI" use="optional"/>
</xsd:complexType>
```

### 8.2.3.2 Harvest Operation

This is the pull mechanism that 'pulls' data into the catalogue. That is, this operation only references the data to be inserted or updated in the catalogue, and it is the job of the

## OGC 07-045r2

catalogue service to resolve the reference, fetch that data, and process it into the catalogue.

The **Harvest** operation has two modes of operation, controlled by a flag in the request. The first mode of operation is a synchronous mode in which the CSW receives a **Harvest** request from the client, processes it immediately, and sends the results to the client while the client waits. The second mode is asynchronous in that the server receives a **Harvest** request from the client, and sends the client an immediate acknowledgement that the request has been successfully received (see [OGC 07-006]).

### 8.2.3.2.1 Request

Table 38 specifies the parameters for the Harvest operation request (KVP and XML). The column **ISO Metadata Profile** shows syntax and/or semantics restrictions or variations in comparison to that of the base spec. The encoding in the table is directly suitable for the HTTP GET binding. The schema for the XML encoding is defined in [OGC 07-006].

**Table 38 - Parameters in Harvest operation request**

| Keyword   | Datatype & Value   | Optionality  | ISO Metadata Profile              |
|-----------|--|--|-----------------------------------|
| REQUEST   | Character String.<br>Fixed value of “Harvest”.<br>The value is case insensitive.   | Mandatory  | Mandatory                         |
| SERVICE   | Character String.<br>Fixed value of “CSW”  | Mandatory  | Mandatory<br>Fixed value of “CSW” |
| VERSION   | Character String.<br>Fixed value of “2.0.2”  | Mandatory  | Mandatory                         |
| NAMESPACE | List of Character String,<br>comma separated<br><br>Used to specify a namespace and its prefix<br><br>Format shall be <code>xmlns([prefix]=url)</code> . If the <i>prefix</i> is not specified then this is the default namespace. | Zero or one<br>(Optional)<br><br>Include value for each namespace<br><br>If not included, all qualified names are in default namespace | Optional                          |
| SOURCE    | URI<br><br>Reference to the source from which the resource is to be harvested.   | One (Mandatory)  | One<br>(Mandatory)                |

| Keyword         | Datatype & Value  | Optionality  | ISO Metadata Profile   |
|-----------------|---|--|--|
| RESOURCETYPE    | Character String<br>Reference to the type of resource being harvested.<br><br>Example:<br><a href="http://www.isotc211.org/schemas/2005/gmd/">http://www.isotc211.org/schemas/2005/gmd/</a> | One (Mandatory)  | One (Mandatory)<br><br>At a minimum the catalogue must be able to harvest an ISO19139 metadata document as defined in the information model of this profile. Therefore it must support ‘ <a href="http://www.isotc211.org/schemas/2005/gmd/">http://www.isotc211.org/schemas/2005/gmd/</a> ’ <sup>34</sup> as resource type. |
| RESOURCEFORMAT  | Character String<br>MIME type indicating format of the resource being harvested   | Zero or one (Optional)<br>Default value is <i>application/xml</i>        | Zero or one (Optional)<br>Default value is <i>application/xml</i>  |
| RESPONSEHANDLER | URL<br>A reference to a person or entity that the CSW should respond to when it has completed processing Harvest request asynchronously (e.g. an email address)                             | Zero or one (Optional)<br>If not included, process request synchronously | Zero or one (Optional)<br>If not included, process request synchronously   |

<sup>34</sup> Profiles of this must be detected by the server.

| Keyword         | Datatype & Value                                    | Optionality  | ISO Metadata Profile  |
|-----------------|---|--|---|
| HARVESTINTERVAL | Period<br>Must conform to ISO8601<br>Period syntax. | Zero or one<br>(Optional)<br>If not specified, then<br>harvest only once in<br>response to the<br>request. | Zero or one<br>(Optional)<br>If not specified,<br>then harvest<br>only once in<br>response to the<br>request. |

An example for the Harvest request is described in Annex G.

### 8.2.3.2.2 Response

The **Harvest** operation can respond in one of two ways depending on the presence or absence of the **ResponseHandler** parameter.

If the **ResponseHandler** parameter is present, then the CSW server should verify the request syntax and immediately respond to the client with an acknowledgment message as defined in Subclause 10.12.4.4 of [OGC 07-006]. Later, after the server has processed the request, it shall generate a **HarvestResponse** message and send it to the URI specified by the **ResponseHandler** parameter using the protocol encoded therein.

If the **ResponseHandler** parameter is not present, then the CSW server shall process the **Harvest** request immediately and respond to the waiting client with a **HarvestResponse** message.

If the **Harvest** attempt is successful, this response may include summary representations of the newly created or modified catalogue object(s). The response is the same as the **TransactionResponse**. In the **TransactionResultType** belonging to **TransactionResponseType** there is a reference used to report a brief representation of each new record, including the record identifier, created in the catalogue.

The following XML-Schema fragment defines the **HarvestResponse** message:

#### Listing 5 - HarvestResponse definition

```
<xsd:element name="HarvestResponse" type="csw:HarvestResponseType"
  id="HarvestResponse">
  </xsd:element>
  <xsd:complexType name="HarvestResponseType" id="HarvestResponseType">
    <xsd:choice>
      <xsd:element ref="csw:Acknowledgement"/>
      <xsd:element ref="csw:TransactionResponse"/>
    </xsd:choice>
  </xsd:complexType>
```



### 8.2.3.3 Record locking

This specification does not define a locking interface, instead relying on the underlying repository to mediate concurrent access to catalogue records.

### 8.2.4 Error handling

In the event that the submitted request is invalid, an exception report message is generated and returned to the client. This report complies with the definition of exception reports that are specified by OGC Common specification (see [OGC 05-008c1]). Table 39 shows an excerpt from that document that lists valid exception codes and meanings that are supported by this profile<sup>35</sup>.

**Table 39 - Exception codes and meanings (from OGC Common)**

| exceptionCode value   | Meaning of code   | “locator” value                      |
|---|---|--------------------------------------|
| MissingParameterValue   | Operation request does not include a parameter value, and this server did not declare a default value for that parameter                                    | Name of missing parameter            |
| InvalidParameterValue   | Operation request contains an invalid parameter value a   | Name of parameter with invalid value |
| VersionNegotiationFailed  | List of versions in “AcceptVersions” parameter value, in GetCapabilities operation request, did not include any version supported by this server            | None, omit “locator” parameter       |
| InvalidUpdateSequence   | Value of (optional) updateSequence parameter, in GetCapabilities operation request, is greater than current value of service metadata updateSequence number | None, omit “locator” parameter       |
| NoApplicableCode  | No other exceptionCode specified by this service and server applies to this exception   | None, omit “locator” parameter       |
| a When an invalid parameter value is received, it seems desirable to place the invalid value(s) in ExceptionText string(s) associated with the InvalidParameterValue value. |   |                                      |

The XML encoding of an exception has to comply with owsExceptionReport.xsd that is attached to the further mention OGC Common specification. See this document for details.

<sup>35</sup> In future versions of this profile additional values for the exceptionCode parameter will be defined

### 8.3 Query facilities

The interoperability goal is supported by the specification of a minimal abstract query (predicate) language, which must be supported by all compliant OGC Catalogue Services. This query language is called OGC\_Common Catalogue Query Language (CQL) (see [OGC 07-006]). It supports nested Boolean queries, text matching operations, temporal data types, and geospatial operators. CQL assists the consumer in the discovery of datasets of interest at all sites supporting the OGC Catalogue Services.

OGC Filter Encoding is an XML based encoding of the OGC\_Common Query Language. This query language (Version 1.1.0) must be supported by all catalogue instances of this profile in order to support search interoperability. In addition, the plain textual encoding of CQL version 2.0 may be supported. The capabilities document of the catalogue instance shall describe all supported query languages (see Capabilities Document in Annex E).

The following conditions must be met by the supported query language:

- support for the logical operators:
  - And
  - Or
  - Not
- support for the comparison operators:
  - EqualTo
  - NotEqualTo
  - LessThan
  - GreaterThan
  - LessThanOrEqualTo
  - GreaterThanOrEqualTo
  - Like
  - NullCheck
- support for the following expressions:
  - property name
  - literal

- support for the following spatial operators<sup>36</sup>:
  - Intersects
  - Disjoint
  - BBOX

If the value of a search parameter in a metadata entry is a missing value, then the metadata set entry does not fulfill this search condition.

Catalogue instances must ensure that the capabilities for searching tightly-coupled services (based on the queryable properties defined in table 14) is implemented (see 7.2.4).

## 8.4 Implementation guidance

The following section gives developers help when setting up a catalogue service instance that complies with the defined application profile. Any information provided here is non-normative or is an detailing of former descriptions.

### 8.4.1 Technical issues

**HTTP:** The base communication protocol is HTTP 1.1 as specified by IETF RFC 2616 (<http://www.ietf.org/rfc/rfc2616>). All bindings of operations (see Table 26) MUST be consistent with HTTP/1.1 semantics. Alternative bindings may be specified for a specific service instance. Any HTTP/1.1 response message containing an entity-body must include a Content-Type header field defining the media type of that body (RFC 2616, 7.2.1). This includes the charset parameter (“application/xml; charset=utf-8”).

**SOAP:** Only SOAP messaging (via HTTP/POST) with document/literal style has to be used. Messages must be compliant with SOAP 1.2 (<http://www.w3.org/TR/SOAP/>). The message payload will be in the body of the SOAP envelope.

### 8.4.2 Semantic issues

**Keywords:** In metadata sets, keywords shall describe the essentials of the contents of the described resource. Ideally, the selected keywords shall comply with a given taxonomy that any catalogue uses for both metadata maintenance and queries.

In case of using the appropriate metadata version the contents of ‘metadataStandardName’ and ‘metadataStandardVersion’ in a metadata set shall comply with one of the following conventions:

In case of dataset, datasetcollection and application

---

<sup>36</sup> all spatial operators must support geometries in WGS84 (see 7.2.3.1).

## OGC 07-045r2

- metadataStandardName: 'ISO19115'
- metadataStandardVersion: '2003/Cor.1:2006'

In case of service

- metadataStandardName: 'ISO19119'
- metadataStandardVersion: '2005/Amd 1:2008'

'serviceType' in a metadata set shall comply with the OGC abbreviations in common use: e. g. 'WMS', 'WFS', 'CSW'.

Furthermore, it is recommended that taxonomies are supported on search queryables wherever possible.

Any identifier in a metadata set (most notably `MD_Metadata.fileIdentifier` and `MD_Metadata.parentIdentifier`) shall comply with a UUID (Universal Unique Identifier, as specified by <http://www.ietf.org>). The usage of UUIDs is recommended to ensure the uniqueness of metadata sets across several catalogue services.

The brief result set which substitutes `<xs:any>` of a transaction response (`<TransactionResultType>`) should include the **identifier (fileIdentifier)** element.

### 8.4.3 Metadata set examples

Examples for metadata records describing a service instance that complies with the given schemas are attached to Annex D1 and D2 of this document.

An example for a metadata record describing a dataset instance is quite similar and not included with this document.

### 8.5 Security considerations

This document does not demand any specific security considerations regarding a compliant catalogue service. Security issues are part of the implementation specification of a catalogue service.

But it is recommended that HTTP Basic Authentication is used to prevent access to the URLs of the transaction interface, unless the requestor can provide user/password credentials. This basic authentication should be used in conjunction with HTTPS as part of a security solution.

## **Annex A**

### **(normative)**

### **Abstract test suite**

#### **A.1 Read-only CSW**

##### **A.1.1 Basic CSW Client**

###### **A.1.1.1 Basic service elements**

- a) Test purpose: Verify that a CSW client satisfies the requirements for request parameter rules.
- b) Test method: Generate an adequate sample of requests from the client and verify that each is a valid request.
- c) Reference: 8.1
- d) Test type: Basic

###### **A.1.1.2 GetCapabilities Request**

- a) Test purpose: Verify that a CSW client satisfies all requirements for a GetCapabilities request.
- b) Test method: Generate an adequate sample of GetCapabilities requests from the client and verify that each is a valid request.
- c) Reference: 8.2.1.1
- d) Test type: Basic

###### **A.1.1.3 GetRecords Request**

- a) Test purpose: Verify that a CSW client satisfies all requirements for a GetRecords request.
- b) Test method: Generate an adequate sample of GetRecords requests from the client and verify that each is a valid request.
- c) Reference: 8.2.2.1.1
- d) Test type: Basic

###### **A.1.1.4 GetRecordById Request**

- a) Test purpose: Verify that a CSW client satisfies all requirements for a GetRecordById request.
- b) Test method: Generate an adequate sample of GetRecordById requests from the client and verify that each is a valid request.
- c) Reference: 8.2.2.2.1
- d) Test type: Basic

###### **A.1.1.5 DescribeRecord Request**

- a) Test purpose: Verify that a CSW client satisfies all requirements for a DescribeRecord request.
- b) Test method: Generate an adequate sample of DescribeRecord requests from the client and verify that each is a valid request.
- c) Reference: 8.2.2.3.1
- d) Test type: Basic

A.1.1.6 GetDomain Request

- a) Test purpose: Verify that a basic CSW client satisfies all requirements for a GetDomain request.
- b) Test method: Generate an adequate sample of GetDomain requests from the client and verify that each is a valid request.
- c) Reference: 8.2.2.4.1
- d) Test type: Basic

A.1.2 CSW Server

A.1.2.1 Version negotiation

- a) Test Purpose: Verify that a CSW server interface satisfies the requirements for version negotiation.
- b) Test Method: Submit requests containing version number both lower than and higher than the version supported by the server. Verify that the server responses in accord with the rules for version negotiation.
- c) Reference: 8.2.1.1
- d) Test Type: Basic

A.1.2.2 Request parameter rules

- a) Test Purpose: Verify that a CSW server interface satisfies the requirements for request parameter rules.
- b) Test Method: Generate a sample of requests from a client. Include both invalid requests and valid request that vary within the limits allowed by the rules. Verify that the server provides an appropriate response in each case.
- c) Reference: 8.2.1
- d) Test Type: Basic

A.1.2.3 GetCapabilities response

- a) Test Purpose: Verify that a basic CSW server interface satisfies all requirements of the GetCapabilities operation.
- b) Test Method: Make several GetCapabilities requests using a variety of input parameters. Verify that an appropriate response is returned in each case.
- c) Reference: 7.5; 8.2.1.1
- d) Test Type: Basic

## A.1.2.4 GetRecords response

- a) Test Purpose: Verify that a basic CSW server interface satisfies all requirements of the GetRecords operation.
- b) Test Method: Make several GetRecords requests using a variety of input parameters. Verify that an appropriate response is returned in each case.
- c) Reference: 0
- d) Test Type: Basic

## A.1.2.5 GetRecordById response

- a) Test Purpose: Verify that a basic CSW server satisfies all requirements of the GetRecordById operation.
- b) Test Method: Make several GetRecordById requests using a variety of input parameters. Verify that an appropriate response is returned in each case.
- c) Reference: 8.2.2.2.2
- d) Test Type: Basic

## A.1.2.6 DescribeRecord response

- a) Test Purpose: Verify that a basic CSW server interface satisfies all requirements of the DescribeRecord operation.
- b) Test Method: Make several DescribeRecord requests using a variety of input parameters. Verify that an appropriate response is returned in each case.
- c) Reference: 0
- d) Test Type: Basic

## A.1.2.7 GetDomain response

- a) Test Purpose: Verify that a basic CSW server interface satisfies all requirements of the GetDomain operation.
- b) Test Method: Make several GetDomain requests using a variety of input parameters. Verify that an appropriate response is returned in each case.
- c) Reference: 8.2.2.4.2
- d) Test Type: Basic

## A.2 Transactional CSW

## A.2.1 Client

## A.2.1.1 Transaction request

- a) Test Purpose: Verify that a CSW client satisfies all requirements for a Transaction request.
- b) Test Method: Generate an adequate sample of Transaction requests from the client and verify that each is a valid request.
- c) Reference: 8.2.3.1.1

d) Test Type: Basic

A.2.1.2 Harvest request

a) Test Purpose: Verify that a CSW client satisfies all requirements for a Harvest request.

b) Test Method: Generate an adequate sample of Harvest requests from the client and verify that each is a valid request.

c) Reference: 8.2.3.2.1

d) Test Type: Basic

A.2.2 CSW Server

A.2.2.1 Transaction response

a) Test Purpose: Verify that a CSW server interface satisfies all requirements for a Transaction operation.

b) Test Method: Make several Transaction requests using a variety of input parameters. Verify that an appropriate response is returned in each case.

c) Reference: 8.2.3.1.2

d) Test Type: Basic

A.2.2.2 Harvest response

a) Test Purpose: Verify that a CSW server interface satisfies all requirements for a Harvest operation.

b) Test Method: Make several Harvest requests using a variety of input parameters. Verify that an appropriate response is returned in each case.

c) Reference: 0

d) Test Type: Basic



## **Annex B** **(informative)**

### **Design rationale**

The CSW catalogue profile at hand is intended to provide a catalogue service for managing metadata resources that comply with 19115:2003/Cor.1:2006 and ISO19119:2005/Amd 1:2008. Based on this information model many resources might be described and managed:

- Geodata:
  - dataset, that is an identifiable collection of data;
  - datasetcollection, that are a collection of datasets sharing the same product specification;
- Service that is an instance of a service hosted on a specific set of hardware and accessible over a network. A service is either tightly or loosely coupled.
  - Tightly coupled, that is a service that is associated with a specific dataset or datasetcollection.
  - Loosely coupled, that is a service that is not associated with a specific dataset or datasetcollection.
- Application, that is an information resource that is hosted on a specific set of hardware and accessible over a network

These are the mandatory information resources that are managed by the catalogue service. According to 19115:2003/Cor.1:2006, additional resources might be described and thus be managed by the catalogue service.

The catalogue service specifies the HTTP protocol binding and is thus accessible over the Internet. It provides powerful search capabilities, including spatial searches.

One major design goal is to provide interoperability at the highest grade between distinct catalogue services. This level of interoperability if either realized between catalogue services that comply with this application profile, or between any catalogue services that comply with the base specification of CSW 2.0.2.

**Annex C**  
(informative)

**WSDL Specification**

An example can be found in the OGC schema repository.

## **Annex D1 (normative)**

### **XML Schemas**

#### **D.1.1 XML Schema Document files of this specification in general**

In addition to this document, this specification includes normative XML Schema Document files. The CSW 2.0.2-, ISO19139- and the AP ISO 1.0 XML Schema Documents are posted together online at the URL <http://schemas.opengis.net>. For ISO19139 the most recent version (dated: April 17, 2007) which is available at the time of publication of this specification is used. These XML Schema Documents are also bundled with the present document. In the event of a discrepancy between the bundled and online versions of the XML Schema files, the online files shall be considered authoritative.

#### **D.1.2 XML encoding for the ‘brief’, ‘summary’ and ‘full’ result sets**

The XML encoding for the three result sets is based on the full ISO/TS 19139 XML Schema Implementation of ISO 19115 (as defined in Clause 9 of ISO/TS 19139) extended with the XML Schema Implementation of ISO 19119 described herein.

The elements that should be included in each set are specified in clauses 7.4.1, 7.4.2 and 7.4.3 of this specification. Validation of a result set is done against the whole set of ISO/TS 19139 XML Schemas. The additional constraints defined in clauses 7.4.1, 7.4.2 and 7.4.3 can be tested with other tools such as XSLT style sheets.

#### **D.1.3 XML encoding for service metadata**

The description of service metadata follows the ISO 19119 standard with the changes described in the amendment proposal ISO 19119:2005/Amd 1:2008.

The implementation of ISO 19119:2005/Amd 1:2008 follows the encoding rules stated in Clause 8 of ISO/TS 19139. Some specificities of the ISO 19119:2005/Amd 1:2008 UML models, and especially qualifiers, require the use of externally identified implementations as defined in clause 8.5.8 of ISO/TS 19139. This clause uses the UML notation commonly used in the ISO 19100 series of Standards, plus the realization concept and the implementation stereotypes defined in ISO/TS 19139 clause 5.4.

The namespace of the ISO 19119:2005/Amd 1:2008 XML implementation is <http://www.isotc211.org/2005/srv>. This namespace is abbreviated *srv* that stands for *SeRVice*.

### D.1.4 XML namespaces

The Figure 11 below shows the different namespaces used to implement ISO 19119:2005/ Amd 1:2008 (grey boxes) along with the relationships between these namespaces and the ISO 19100 series packages (white boxes).

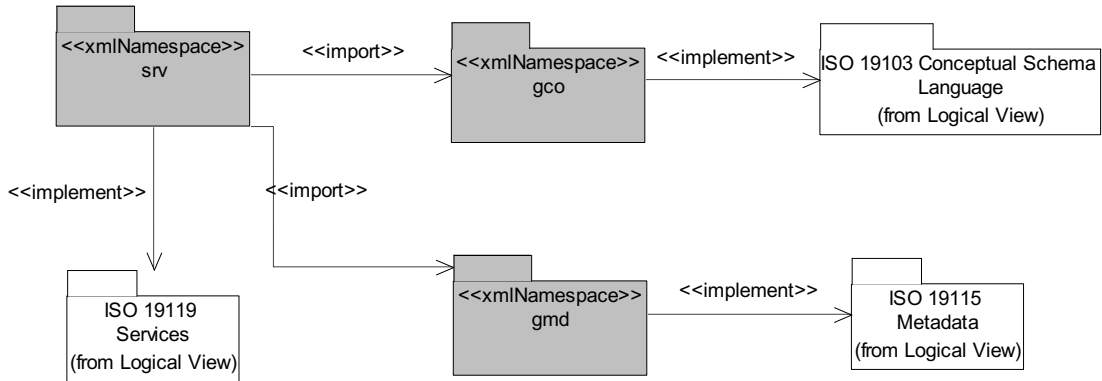
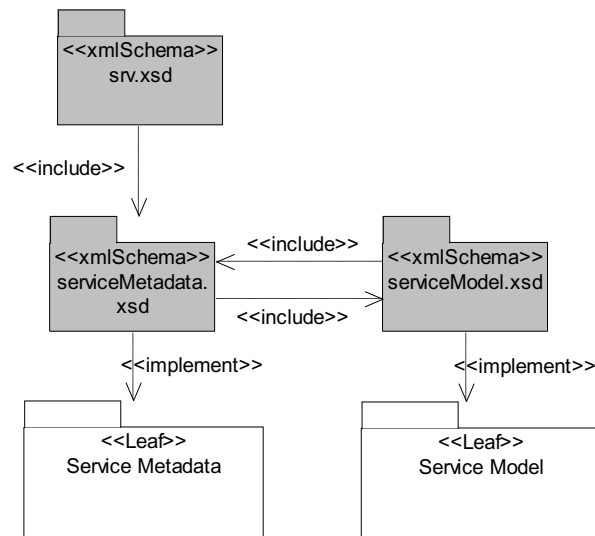

**Figure 11 - XML Packaging**

#### srv namespace

#### Organization of the srv namespace

This namespace contains the implementation of ISO 19119:2005/Amd 1:2008 as defined in the present amendment. The root of this namespace is srv.xsd.



**Figure 12 - Organization of the srv namespace**

**srv.xsd**

This XML schema includes (directly or indirectly) all the implemented concepts of the srv namespace, but it does not contain the declaration of any types.

**serviceMetadata.xsd**

This XML schema implements the Service Metadata UML package and its abstract concepts. It contains the implementation of the following classes: SV\_Parameter, SV\_OperationMetadata, SV\_ServiceIdentification, SV\_OperationChain, SV\_OperationChainMetadata, SV\_CoupledResource, SV\_ParameterDirection, DCPLList, SV\_CouplingType.

The classes implemented in this XML schema follow the encoding rules described in ISO/TS 19139 clause 8. Some UML models of this package make use of qualifiers that require the use of clause 8.5.8 of ISO/TS 19139:

- SV\_Parameter: in order to implement in XML the qualifier on the relationship between SV\_Parameter and SV\_OperationMetadata, the XML property name with type gco:MemberName\_PropertyType is added to the definition of srv:SV\_Parameter\_Type.
- SV\_OperationMetadata: because of the qualifier on the relationship between SV\_OperationMetadata and SV\_Parameter, the multiplicity of the parameters property is implemented as [0..\*].

Figure 13 below shows the XML implementation of SV\_Parameter and SV\_OperationMetadata.

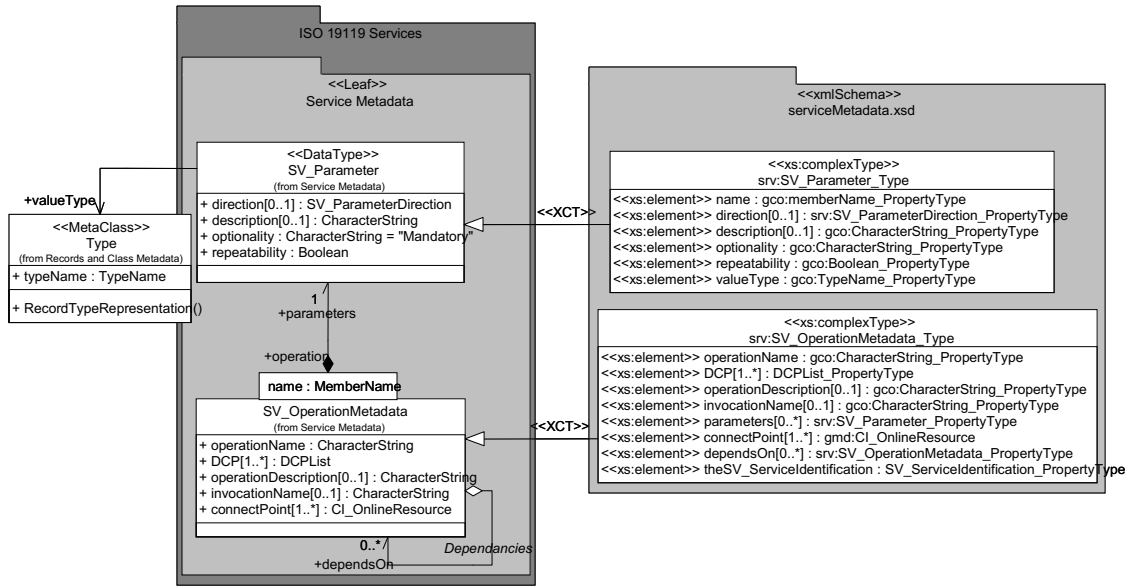

Figure 13 - SV\_Parameter and SV\_OperationMetadata data types implemented in XML Schema

**Implementation notes:**

1. The multiplicity of SV\_ServiceIdentification.restrictions is defined as [0..1] in clause C.2.2 4. of ISO 19119, although the definition specifies that this element describes legal and security constraints. In ISO 19115, all constraint elements are specified with a maximum cardinality of n. The multiplicity of restrictions has been modified to [0..\*].
2. MD\_Constraints is incorrectly spelled MD\_DataConstraints in clause 2.2.2 4. of ISO 19119. restrictions have been implemented with type MD\_Constraints.
3. The order of SV\_ServiceIdentification attributes is different in the UML Model and the data dictionary. The order of the UML model has been chosen so that the mandatory property couplingType appears first.
4. The data dictionary is not complete on SV\_OperationMetadata: two relevant properties description and operation are present in the UML models but they are not described in the data dictionary. They have been implemented in the XML Schemas.

**serviceModel.xsd**

This XML schema implements the Service Model UML package and its abstract concepts. It contains the implementation of the following classes: SV\_ServiceSpecification, SV\_PlatformNeutralServiceSpecification,

SV\_PlatformSpecificServiceSpecification, SV\_ServiceType, SV\_Port, SV\_Service, SV\_Interface, SV\_PortSpecification, SV\_Operation, SV\_OperationModel.

The classes implemented in this XML schema follow the encoding rules described in ISO/TS 19139 clause 8. Some UML models of this package make use of qualifiers that require the use of clause 8.5.8 of ISO/TS 19139:

- SV\_PortSpecification: the association class is implemented as a class. SV\_Interface has a unidirectional aggregation relationship to SV\_SpecificationPort with a multiplicity of [0..1] and SV\_PortSpecification has a unidirectional relationship to SV\_Port with a multiplicity of 1.

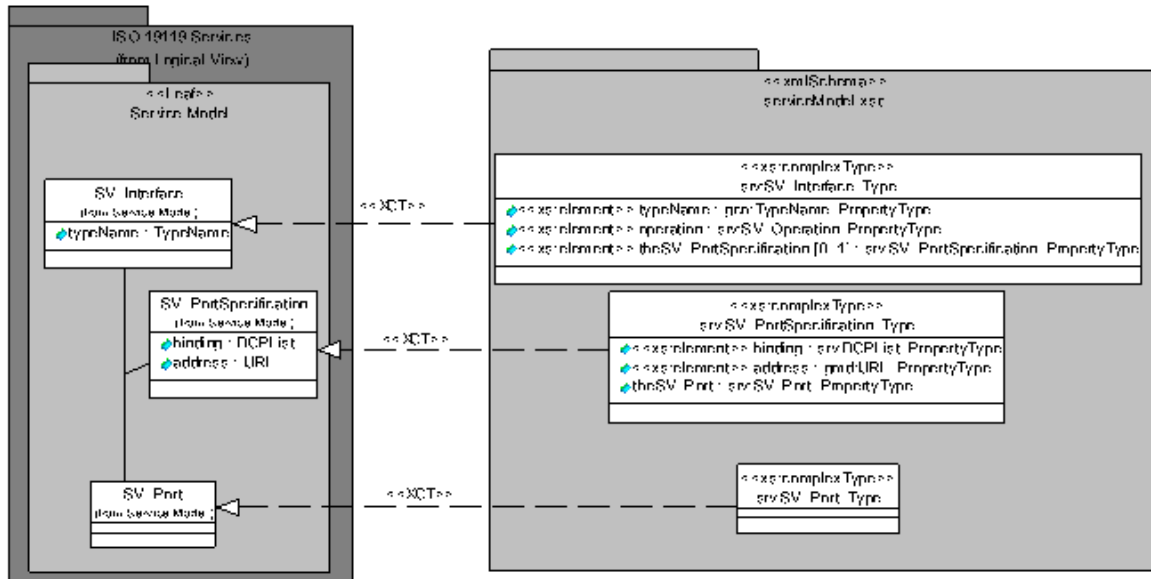
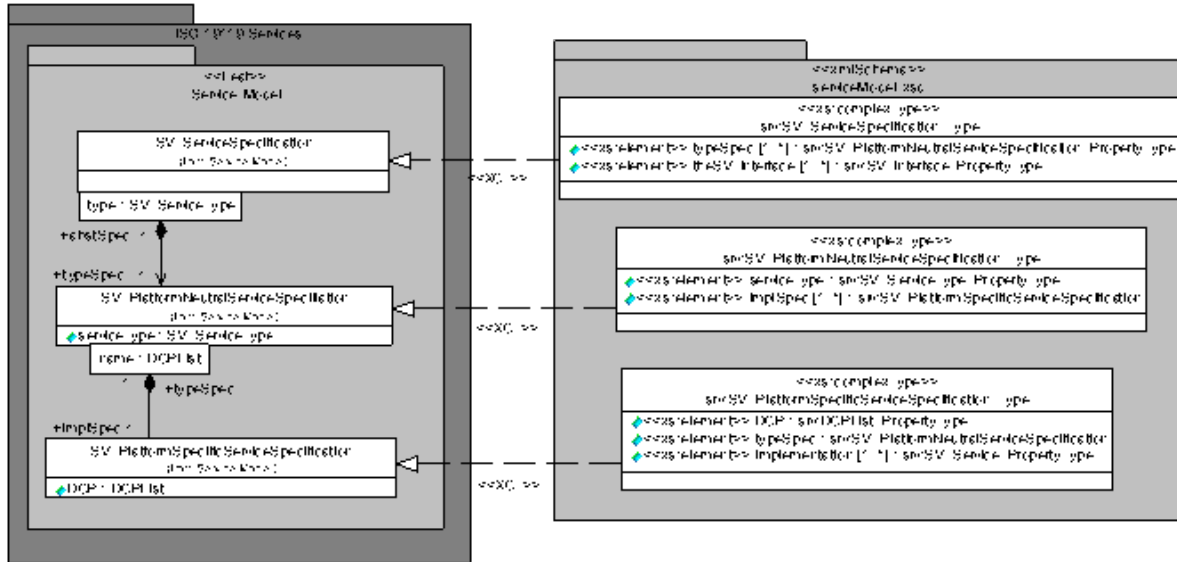

Figure 14 - SV\_Interface, SV\_PortSpecification and SV\_Port data types implemented in XML Schema

- SV\_ServiceSpecification, SV\_PlatformNeutralServiceSpecification and SV\_PlatformSpecificServiceSpecification: because of the qualifiers on the relationships between SV\_ServiceSpecification and SV\_PlatformNeutralServiceSpecification and SV\_PlatformSpecificServiceSpecification, the multiplicity of SV\_ServiceSpecification.typeSpec and SV\_PlatformNeutralServiceSpecification.implSpec are implemented as [1..\*].

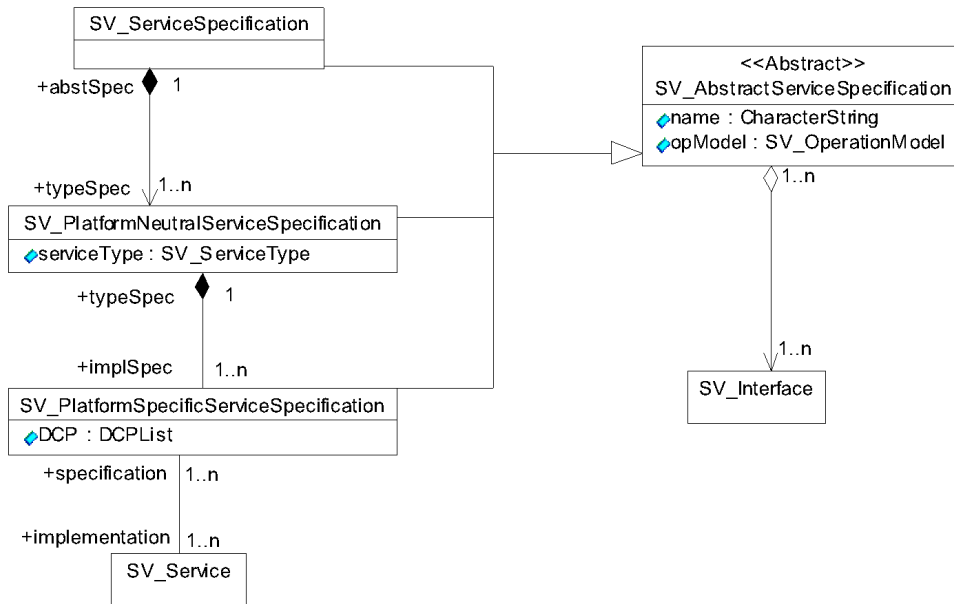

**Figure 15 - SV\_ServiceSpecification, SV\_PlatformNeutralServiceSpecification and SV\_PlatformSpecificServiceSpecification data types implemented in XML Schemas**

**Implementation notes**

1. The concepts described on Figure 1 of ISO 19119 make use simultaneously of inheritance and aggregation relationships. It is understood that the inheritance relationship has been primarily designed as a way to share the properties of the superclass with its children and not the composition relationships. For instance, the child class SV\_PlatformSpecificServiceSpecification inherits from the aggregation relationships to SV\_PlatformNeutralServiceSpecification and to itself. In order to clarify the situation, the UML model has been modified: an abstract superclass SV\_AbstractServiceSpecification has been created with the two attributes name and opModel and the relationship to SV\_Interface. The three other classes derive from this superclass while the aggregation relationships that link them together are preserved. The modified modeling is pictured below.





**Figure 16 - Modification of the modeling of abstract to implementation service specifications**

2. SV\_ServiceType is defined as a type with no properties and intended for handling the service categories described in clause 8. It has been implemented as a CodeList.

### D.1.5 XML encoding for the wrapper base schema

```

<?xml version="1.0" encoding="utf-8"?>
<xs:schema targetNamespace="http://www.isotc211.org/2005/gmd"
elementFormDefault="qualified" version="0.1"
xmlns:xs="http://www.w3.org/2001/XMLSchema"
xmlns:xlink="http://www.w3.org/1999/xlink"
xmlns:gmd="http://www.isotc211.org/2005/gmd">
  <!-- ===== Annotation
===== -->
  <xs:annotation>
    <xs:documentation>ISO Wrapper to import service related type into the gmd
namespace</xs:documentation>
  </xs:annotation>
  <!-- ===== Imports
===== -->
  <xs:include schemaLocation="../gmd/gmd.xsd"/>
  <xs:include schemaLocation="../isoap/services.xsd"/>
</xs:schema>

```

## D.1.6 Example: metadata record describing a service instance

```

<?xml version="1.0" encoding="UTF-8"?>
<!-- Core gmd based instance document -->
<MD_Metadata xmlns="http://www.isotc211.org/2005/gmd"
  xmlns:srv="http://www.isotc211.org/2005/srv"
  xmlns:xsi="http://www.w3.org/2001/XMLSchema-instance"
  xmlns:gco="http://www.isotc211.org/2005/gco"
  xsi:schemaLocation="http://www.isotc211.org/2005/gmd ../apiso/apiso.xsd">
  <fileIdentifier>
    <gco:CharacterString>33462e89-e5ab-11c3-737d-
b3a61366d028</gco:CharacterString>
  </fileIdentifier>
  <language>
    <gco:CharacterString>eng</gco:CharacterString>
  </language>
  <hierarchyLevel>
    <MD_ScopeCode
codeList="http://metadata.dgiwg.org/codelistRegistry?MD_ScopeCode"
codeListValue="service"/>
  </hierarchyLevel>
  <hierarchyLevelName>
    <gco:CharacterString>urn:eustat:georesource:service:WMS:</gco:CharacterSt
ring>
  </hierarchyLevelName>
  <contact>
    <CI_ResponsibleParty>
      <individualName>
        <gco:CharacterString>Uwe Voges</gco:CharacterString>
      </individualName>
      <organisationName>
        <gco:CharacterString>con terra
GmbH</gco:CharacterString>
      </organisationName>
      <contactInfo>
        <CI_Contact>
          <address>
            <CI_Address>
              <electronicMailAddress>
                <gco:CharacterString>voges@conterra.de</gco:CharacterString>
              </electronicMailAddress>
            </CI_Address>
          </address>
        </CI_Contact>
      </contactInfo>
      <role>
        <CI_RoleCode
codeList="http://www.isotc211.org/2005/resources/codeList.xml#CI_RoleCode"
codeListValue="author">author</CI_RoleCode>
      </role>
    </CI_ResponsibleParty>
  </contact>
  <dateStamp>
    <gco>Date>2007-03-09</gco>Date>
  </dateStamp>
  <metadataStandardName>
    <gco:CharacterString>ISO19119</gco:CharacterString>

```

```

</metadataStandardName>
<metadataStandardVersion>
  <gco:CharacterString>2005/PDAM 1</gco:CharacterString>
</metadataStandardVersion>
<identificationInfo>
  <srv:SV_ServiceIdentification>
    <citation>
      <CI_Citation>
        <title>
          <gco:CharacterString>JRC - Image 2000
multispectral (BO 321)</gco:CharacterString>
        </title>
        <date>
          <CI_Date>
            <date>
              <gco:Date>2006-01-
06</gco:Date>
            </date>
            <dateType>
              <CI_DateTypeCode
codeList="http://www.isotc211.org/2005/resources/codeList.xml#CI_DateTypeCode"
codeListValue="creation">creation</CI_DateTypeCode>
            </dateType>
          </CI_Date>
        </date>
        <date>
          <CI_Date>
            <date>
              <gco:Date>2006-05-
18</gco:Date>
            </date>
            <dateType>
              <CI_DateTypeCode
codeList="http://www.isotc211.org/2005/resources/codeList.xml#CI_DateTypeCode"
codeListValue="revision">revision</CI_DateTypeCode>
            </dateType>
          </CI_Date>
        </date>
        <citedResponsibleParty>
          <CI_ResponsibleParty>
            <organisationName>
              <gco:CharacterString>Joint
Research Center</gco:CharacterString>
            </organisationName>
            <contactInfo>
              <CI_Contact>
                <phone>

                <CI_Telephone>
                  <voice>
                    <gco:CharacterString>+39 0332785052</gco:CharacterString>
                  </voice>
                </CI_Telephone>

                </phone>
              </onlineResource>
            </contactInfo>
          </CI_ResponsibleParty>
        </citedResponsibleParty>
      </CI_Citation>
    </citation>
  </srv:SV_ServiceIdentification>
</identificationInfo>

```

## OGC 07-045r2

```
<CI_OnlineResource>
  <linkage>
    <URL>http://www.jrc.ec.europa.eu</URL>
  </linkage>
</CI_OnlineResource>
</onlineResource>
  </CI_Contact>
</contactInfo>
  <role>
    <CI_RoleCode
codeList="http://www.isotc211.org/2005/resources/codeList.xml#CI_RoleCode"
codeListValue="publisher">publisher</CI_RoleCode>
  </role>
  </CI_ResponsibleParty>
</citedResponsibleParty>
</CI_Citation>
</citation>
<abstract>
  <gco:CharacterString>Image2000 products are intended
to be the main source of data for updating the European Land Cover database
(CORINE Land Cover), but are also reference data in themselves. Primarily
derived from Landsat 7 Enhanced Thematic Mapper ETM+ imagery, they are
georeferenced and orthorectified, resulting in a consistent, high quality
product. Image2000 products currently cover the entire European Union. Image2000
data are multi-user and multi-purpose, covering a wide range of potential
applications. Individual orthorectified scenes in national map projection system
(approximately 1000 scenes, 25m resolution (multispectral) and 12.5m
panchromatic).</gco:CharacterString>
</abstract>
  <graphicOverview>
    <MD_BrowseGraphic>
      <fileName>
        <gco:CharacterString>http://mapserver.jrc.it/website/image2000/viewer.htm
</gco:CharacterString>
      </fileName>
      <fileDescription>
        <gco:CharacterString>preview
map</gco:CharacterString>
      </fileDescription>
      <fileType>
        <gco:CharacterString>html</gco:CharacterString>
      </fileType>
    </MD_BrowseGraphic>
  </graphicOverview>
  <descriptiveKeywords>
    <MD_Keywords>
      <keyword>
        <gco:CharacterString>Image2000</gco:CharacterString>
      </keyword>
      <keyword>
        <gco:CharacterString>Land
management</gco:CharacterString>
```

```

        </keyword>
        <keyword>
            <gco:CharacterString>CORINE Land
Cover</gco:CharacterString>
        </keyword>
        <keyword>
            <gco:CharacterString>Landsat
7</gco:CharacterString>
        </keyword>
        <keyword>
            <gco:CharacterString> Enhanced Thematic
Mapper ETM+ imagery</gco:CharacterString>
        </keyword>
        <type>
            <MD_KeywordTypeCode
codeList="http://metadata.dgiwg.org/codelistRegistry?MD_KeywordTypeCode"
codeListValue="theme"/>
        </type>
    </MD_Keywords>
</descriptiveKeywords>
<resourceConstraints>
    <MD_LegalConstraints>
        <useLimitation>
            <gco:CharacterString>see:
http://europa.eu/geninfo/legal_notices_en.htm</gco:CharacterString>
        </useLimitation>
    </MD_LegalConstraints>
</resourceConstraints>
<srv:serviceType>
    <gco:LocalName>WMS</gco:LocalName>
</srv:serviceType>
<srv:serviceTypeVersion>
    <gco:CharacterString>1.1.1</gco:CharacterString>
</srv:serviceTypeVersion>
<srv:extent>
    <EX_Extent>
        <geographicElement>
            <EX_GeographicBoundingBox>
                <westBoundLongitude>
                    <gco:Decimal>-
61.90</gco:Decimal>
                </westBoundLongitude>
                <eastBoundLongitude>
                    <gco:Decimal>64.35</gco:Decimal>
                </eastBoundLongitude>
                <southBoundLatitude>
                    <gco:Decimal>-
20.94</gco:Decimal>
                </southBoundLatitude>
                <northBoundLatitude>
                    <gco:Decimal>71.61</gco:Decimal>
                </northBoundLatitude>
            </EX_GeographicBoundingBox>
        </geographicElement>
    </EX_Extent>
</srv:extent>
<srv:coupledResource>

```

```

        <srv:SV_CoupledResource>
            <srv:operationName>

        <gco:CharacterString>GetMap</gco:CharacterString>
            </srv:operationName>
            <srv:identifier>
                <gco:CharacterString>3B20D603-30D1-47D5-
AC62-E10193CDE1D8</gco:CharacterString>
            </srv:identifier>
        </srv:SV_CoupledResource>
    </srv:coupledResource>
    <srv:couplingType>
        <srv:SV_CouplingType
codeList="http://someurl#SV_CouplingType" codeListValue="tight"/>
    </srv:couplingType>
    <srv:containsOperations>
        <srv:SV_OperationMetadata>
            <srv:operationName>

        <gco:CharacterString>GetCapabilities</gco:CharacterString>
            </srv:operationName>
            <srv:DCP>
                <srv:DCPList
codeList="http://someurl#DCPList" codeListValue="HTTPGet"/>
            </srv:DCP>
            <srv:connectPoint>
                <CI_OnlineResource>
                    <linkage>

                <URL>http://mapserver.jrc.it:80/wmsconnector/com.esri.wms.Esrimap/img2k_3
21_mos?</URL>
                    </linkage>
                </CI_OnlineResource>
            </srv:connectPoint>
        </srv:SV_OperationMetadata>
    </srv:containsOperations>
    <srv:operatesOn uuidref="3B20D603-30D1-47D5-AC62-
E10193CDE1D8"/>
</srv:SV_ServiceIdentification>
</identificationInfo>
<dataQualityInfo>
    <DQ_DataQuality>
        <scope>
            <DQ_Scope>
                <level>
                    <MD_ScopeCode
codeList="http://www.isotc211.org/2005/resources/codeList.xml#MD_ScopeCode"
codeListValue="data">data</MD_ScopeCode>
                </level>
            </DQ_Scope>
        </scope>
    <lineage>
        <LI_Lineage>
            <statement>
                <gco:CharacterString>Image2000 is
produced from ETM+ Landsat 7 satellite, providing both multi-spectral (25 m) and
panchromatic data (12.5 m). As a multi-purpose product, Image2000 meets user
requirements at National and European level. The images are delivered ortho-
rectified in National projection systems, and one European projection system.
Image purchase, ortho-rectification and quality control is centralised. This

```

centralised approach gives advantages in overall management and assures consistency in quality of the end product. Image2000 consists of: Mosaic of Europe compatible with the national mosaics. Resolution and radiometry of satellite data is compatible with satellite data used for former Corine Land Cover (CLC90). No atmospheric calibration is applied, only standard radiometric corrections such as destriping, dropline correction and bit errors.</gco:CharacterString>

```

                                </statement>
                            </LI_Lineage>
                        </lineage>
                    </DQ_DataQuality>
                </dataQualityInfo>
</MD_Metadata>
```

## Annex D2 (normative)

### ISO19119:2005/PDAM1 extended XML Schema

According to the extensions on ISO 19119:2005/Amd 1:2008 in paragraph 7.2.2.2, the resulting XML schema for the class <<SV\_CoupledResourceType>> is defined as follows (changes are red):

```

<!--===== -->
<xs:complexType name="SV_CoupledResource_Type">
  <xs:complexContent>
    <xs:extension base="gco:AbstractObject_Type">
      <xs:sequence>
        <xs:element name="operationName"
type="gco:CharacterString_PropertyType"/>
        <xs:element name="identifier"
type="gco:CharacterString_PropertyType"/>
        <xs:element ref="gco:ScopedName" minOccurs="0" maxOccurs="1"/>
      </xs:sequence>
    </xs:extension>
  </xs:complexContent>
</xs:complexType>
<!-- ..... -->
<xs:element name="SV_CoupledResource" type="srv:SV_CoupledResource_Type"/>
<!-- ..... -->
<xs:complexType name="SV_CoupledResource_PropertyType">
  <xs:sequence>
    <xs:element ref="srv:SV_CoupledResource" minOccurs="0"/>
  </xs:sequence>
  <xs:attributeGroup ref="gco:ObjectReference"/>
  <xs:attribute ref="gco:nilReason"/>
</xs:complexType>
<!-- ===== -->

```

The service example defined in Annex D1 can then be adjusted as follows (focus on the corresponding section only):

```

<srv:coupledResource>
  <srv:SV_CoupledResource>
    <srv:operationName>
      <gco:CharacterString>GetMap</gco:CharacterString>
    </srv:operationName>
    <srv:identifier>
      <gco:CharacterString>3B20D603-30D1-47D5-AC62-
E10193CDE1D8</gco:CharacterString>
    </srv:identifier>
    <gco:ScopedName codeSpace="http://someurl">MyLayerName
    </gco:ScopedName>
  </srv:SV_CoupledResource>
</srv:coupledResource>

```



## Annex E (informative)

### Capabilities Example

```

<?xml version="1.0" encoding="UTF-8"?>
<!-- =====
* Topic:           Capabilities document for a CSW 2.0.2 AP ISO 1.0.0 Catalog
*
* Last update:    29.03.2007
*
* Author:         Uwe Voges (con terra GmbH)
*
===== -->
<csw:Capabilities version="2.0.2"
xmlns:csw="http://www.opengis.net/cat/csw/2.0.2"
xsi:schemaLocation="http://www.opengis.net/cat/csw/2.0.2 ../csw/2.0.2/CSW-
discovery.xsd" xmlns:gmd="http://www.isotc211.org/2005/gmd"
xmlns:ows="http://www.opengis.net/ows" xmlns:ogc="http://www.opengis.net/ogc"
xmlns:xlink="http://www.w3.org/1999/xlink"
xmlns:xsi="http://www.w3.org/2001/XMLSchema-instance">
  <ows:ServiceIdentification>
    <ows:Title>con terra GmbH test catalogue Server</ows:Title>
    <ows:Abstract> Web based Catalogue Service (CS-W 2.0.2/AP ISO 1.0)
for service, datasets and applications</ows:Abstract>
    <ows:Keywords>
      <ows:Keyword>CS-W</ows:Keyword>
      <ows:Keyword>ISO19119</ows:Keyword>
      <ows:Keyword>ISO19115</ows:Keyword>
      <ows:Keyword>con terra</ows:Keyword>
      <ows:Keyword>Catalogue Service</ows:Keyword>
      <ows:Keyword>metadata</ows:Keyword>
    <ows:Type
codeSpace="http://www.conterra.de">theme</ows:Type>
    </ows:Keywords>
    <ows:ServiceType>CSW</ows:ServiceType>
    <ows:ServiceTypeVersion>2.0.2</ows:ServiceTypeVersion>
    <ows:Fees>NONE</ows:Fees>
    <ows:AccessConstraints>Basic authentication (RFC 2617) is required
for all data manipulation requests</ows:AccessConstraints>
    </ows:ServiceIdentification>
    <ows:ServiceProvider>
      <ows:ProviderName>con terra GmbH</ows:ProviderName>
      <ows:ProviderSite xlink:href="http://www.conterra.de"/>
      <ows:ServiceContact>
        <ows:IndividualName>Uwe Voges</ows:IndividualName>
        <ows:PositionName>geospatial systems
architect</ows:PositionName>
        <ows:ContactInfo>
          <ows:Phone>
            <ows:Voice>+49-251-7474-402</ows:Voice>
            <ows:Facsimile>+49-251-7474-
100</ows:Facsimile>
          </ows:Phone>

```

## OGC 07-045r2

```

                <ows:Address>
                    <ows:DeliveryPoint>Marting-Luther-King-Weg
24</ows:DeliveryPoint>
                    <ows:City>Münster</ows:City>

                <ows:AdministrativeArea>NRW</ows:AdministrativeArea>
                    <ows:PostalCode>48165</ows:PostalCode>
                    <ows:Country>Germany</ows:Country>

                <ows:ElectronicMailAddress>voges@conterra.de</ows:ElectronicMailAddress>
                    </ows:Address>
                    <ows:OnlineResource
xlink:href="mailto:voges@conterra.de"/>
                    </ows:ContactInfo>
                </ows:ServiceContact>
            </ows:ServiceProvider>
            <ows:OperationsMetadata>
                <ows:Operation name="GetCapabilities">
                    <ows:DCP>
                        <ows:HTTP>
                            <ows:Get
xlink:href="http://www.conterra.de/catalog?"/>
                            <ows:Post
xlink:href="http://www.conterra.de/catalog?"/>
                            </ows:HTTP>
                        </ows:DCP>
                    <ows:Constraint name="PostEncoding">
                        <ows:Value>XML</ows:Value>
                    </ows:Constraint>
                </ows:Operation>
                <ows:Operation name="DescribeRecord">
                    <ows:DCP>
                        <ows:HTTP>
                            <ows:Post
xlink:href="http://linux2:7070/axis/services/CSW20_Discovery_SOAP_Port"/>
                            </ows:HTTP>
                        </ows:DCP>
                    <ows:Parameter name="TypeName">
                        <ows:Value>csw:Record</ows:Value>
                        <ows:Value>gmd:MD_Metadata</ows:Value>
                    </ows:Parameter>
                    <ows:Parameter name="OutputFormat">
                        <ows:Value>application/xml</ows:Value>
                    </ows:Parameter>
                    <ows:Parameter name="SchemaLanguage">
                        <ows:Value>XMLSCHEMA</ows:Value>
                    </ows:Parameter>
                    <ows:Constraint name="PostEncoding">
                        <ows:Value>SOAP</ows:Value>
                    </ows:Constraint>
                </ows:Operation>
                <ows:Operation name="GetRecords">
                    <ows:DCP>
                        <ows:HTTP>
                            <ows:Post
xlink:href="http://linux2:7070/axis/services/CSW20_Discovery_SOAP_Port"/>
                            </ows:HTTP>
                        </ows:DCP>
                    <ows:Parameter name="TypeName">
                        <ows:Value>csw:Record</ows:Value>

```

```

        <ows:Value>gmd:MD_Metadata</ows:Value>
      </ows:Parameter>
      <ows:Parameter name="OutputFormat">
        <ows:Value>application/xml</ows:Value>
      </ows:Parameter>
      <ows:Parameter name="OutputSchema">
        <ows:Value>http://www.opengis.net/cat/csw/2.0.2</ows:Value>
      </ows:Parameter>
      <ows:Parameter name="SupportedISOQueryables">
        <ows:Value>http://www.isotc211.org/2005/gmd</ows:Value>
        <ows:Value>http://www.adv.de/extendedISO</ows:Value>
      </ows:Parameter>
      <ows:Parameter name="ResultType">
        <ows:Value>hits</ows:Value>
        <ows:Value>results</ows:Value>
        <ows:Value>validate</ows:Value>
      </ows:Parameter>
      <ows:Parameter name="ElementSetName">
        <ows:Value>brief</ows:Value>
        <ows:Value>summary</ows:Value>
        <ows:Value>full</ows:Value>
      </ows:Parameter>
      <ows:Parameter name="ConstraintLanguage">
        <ows:Value>Filter</ows:Value>
        <ows:Value>CQL_Text</ows:Value>
      </ows:Parameter>
      <ows:Constraint name="SupportedISOQueryables">
        <ows:Value>http://arcims.hamm.de/csw/CSWStartup</ows:Value>
        <ows:Value>Language</ows:Value>
        <ows:Value>AlternateTitle</ows:Value>
        <ows:Value>CreationDate</ows:Value>
        <ows:Value>OrganisationName</ows:Value>
        <ows:Value>HierarchyLevelName</ows:Value>
        <ows:Value>ParentIdentifier</ows:Value>
        <ows:Value>KeywordType</ows:Value>
        <ows:Value>TopicCategory</ows:Value>
        <ows:Value>DatasetLanguage</ows:Value>
        <ows:Value>GeographicDescriptionCode</ows:Value>
        <ows:Value>SpatialResolution</ows:Value>
        <ows:Value>TempExtent_begin</ows:Value>
        <ows:Value>TempExtent_end</ows:Value>
        <ows:Value>ServiceType</ows:Value>
        <ows:Value>ServiceTypeVersion</ows:Value>
        <ows:Value>OperatesOn</ows:Value>
        <ows:Value>Operation</ows:Value>
        <ows:Value>DCP</ows:Value>
        <ows:Value>CouplingType</ows:Value>
      </ows:Constraint>
      <ows:Constraint name="AdditionalQueryables">
        <ows:Value>Fees</ows:Value>
      </ows:Constraint>
    </ows:Operation>
    <ows:Operation name="GetRecordById">
      <ows:DCP>
        <ows:HTTP>
          <ows:Post
xlink:href="http://linux2:7070/axis/services/CSW20_Discovery_SOAP_Port"/>
        </ows:HTTP>
      </ows:DCP>
    </ows:Operation>
  </ows:Operations>

```

```

        </ows:DCP>
        <ows:Parameter name="outputSchema">
<ows:Value>http://www.opengis.net/cat/csw/2.0.2</ows:Value>
<ows:Value>http://www.isotc211.org/2005/gmd</ows:Value>
        <ows:Value>http://www.adv.de/extendedISO</ows:Value>
        </ows:Parameter>
        <ows:Parameter name="ElementSetName">
        <ows:Value>brief</ows:Value>
        <ows:Value>summary</ows:Value>
        <ows:Value>full</ows:Value>
        </ows:Parameter>
    </ows:Operation>
    <ows:Operation name="Harvest">
        <ows:DCP>
            <ows:HTTP>
                <ows:Post
xlink:href="http://linux2:7070/axis/services/CSW20_Publication_SOAP_Port"/>
                </ows:HTTP>
            </ows:DCP>
            <ows:Parameter name="ResourceType">
<ows:Value>http://www.isotc211.org/schemas/2005/gmd</ows:Value>
                <ows:Value>http://www.opengis.net/wms</ows:Value>
            </ows:Parameter>
            <ows:Parameter name="ResourceFormat">
                <ows:Value>application/xml</ows:Value>
                <ows:Value>text/plain</ows:Value>
            </ows:Parameter>
        </ows:Operation>
        <ows:Constraint name="PostEncoding">
            <ows:Value>SOAP</ows:Value>
        </ows:Constraint>
        <ows:Constraint name="FederatedCatalogues">
            <ows:Value>http://arcims.hamm.de/csw/CSWStartup</ows:Value>
        </ows:Constraint>
        <ows:Constraint name="IsoProfiles">
            <ows:Value>http://www.isotc211.org/2005/gmd</ows:Value>
            <ows:Value>http://www.adv.de/extendedISO</ows:Value>
        </ows:Constraint>
        <ows:Constraint name="WSDL">
            <ows:Value>http://www.sdi-
suite.de/csw/services/CSW20_Discovery_SOAP_Port?wsdl</ows:Value>
        </ows:Constraint>
        <ows:Constraint name="XPathQueryables">
            <ows:Value>allowed</ows:Value>
        </ows:Constraint>
    </ows:OperationsMetadata>
    <ogc:Filter_Capabilities xmlns:gml="http://www.opengis.net/gml">
        <ogc:Spatial_Capabilities>
            <ogc:GeometryOperands>
<ogc:GeometryOperand>gml:Envelope</ogc:GeometryOperand>
                <ogc:GeometryOperand>gml:Point</ogc:GeometryOperand>
<ogc:GeometryOperand>gml:LineString</ogc:GeometryOperand>
<ogc:GeometryOperand>gml:Polygon</ogc:GeometryOperand>
            </ogc:GeometryOperands>

```

```

    <ogc:SpatialOperators>
      <ogc:SpatialOperator name="BBOX"/>
      <ogc:SpatialOperator name="Equals"/>
      <ogc:SpatialOperator name="Disjoint"/>
      <ogc:SpatialOperator name="Intersects"/>
      <ogc:SpatialOperator name="Touches"/>
      <ogc:SpatialOperator name="Crosses"/>
      <ogc:SpatialOperator name="Within"/>
      <ogc:SpatialOperator name="Contains"/>
      <ogc:SpatialOperator name="Overlaps"/>
      <ogc:SpatialOperator name="Beyond"/>
    </ogc:SpatialOperators>
  </ogc:Spatial_Capabilities>
  <ogc:Scalar_Capabilities>
    <ogc:LogicalOperators/>
    <ogc:ComparisonOperators>

<ogc:ComparisonOperator>LessThan</ogc:ComparisonOperator>

<ogc:ComparisonOperator>GreaterThan</ogc:ComparisonOperator>

<ogc:ComparisonOperator>LessThanEqualTo</ogc:ComparisonOperator>

<ogc:ComparisonOperator>GreaterThanEqualTo</ogc:ComparisonOperator>

<ogc:ComparisonOperator>EqualTo</ogc:ComparisonOperator>

<ogc:ComparisonOperator>NotEqualTo</ogc:ComparisonOperator>
    <ogc:ComparisonOperator>Like</ogc:ComparisonOperator>

<ogc:ComparisonOperator>Between</ogc:ComparisonOperator>

<ogc:ComparisonOperator>NullCheck</ogc:ComparisonOperator>
    </ogc:ComparisonOperators>
    <ogc:ArithmeticOperators>
      <ogc:SimpleArithmetic/>
    </ogc:ArithmeticOperators>
  </ogc:Scalar_Capabilities>
  <ogc:Id_Capabilities>
    <ogc:EID/>
  </ogc:Id_Capabilities>
</ogc:Filter_Capabilities>
</csw:Capabilities>

```

## Annex F (informative)

### Coupling services with datasets

#### F.1 General coupling between service instance and dataset instance

It is recommended to support the linkage between services and data instances defining equality of:

`MD_DataIdentification.citation.CI_Citation.identifier.MD_Identifier.code` for data metadata and one of

- `SV_ServiceIdentification.operatesOn@uuidref` or
- `SV_ServiceIdentification.operatesOn.MD_DataIdentification.citation.CI_Citation.identifier.MD_Identifier.code`

for service metadata. If the values of those identifiers match, the linkage between the service and the data metadata is properly described. In the case of a tightly or mixed coupled service instance, the value of

- `SV_ServiceIdentification.operatesOn@uuidref` or
- `SV_ServiceIdentification.operatesOn.MD_DataIdentification.citation.CI_Citation.identifier.MD_Identifier.code`

in the service metadata instance must be identical to the value of

`SV_ServiceIdentification.coupledResource.SV_CoupledResource.identifier.CharacterString`.

Catalogue service providers shall ensure that no inconsistencies occur between `SV_ServiceIdentification.operatesOn` and `SV_ServiceIdentification.coupledResource` in this case.

#### F.2 Sophisticated tightly coupled service example

The following sequence diagram shows how an AP ISO Client can query for Web Coverage Services that are tightly-coupled with “landcover” datasets (coverages):

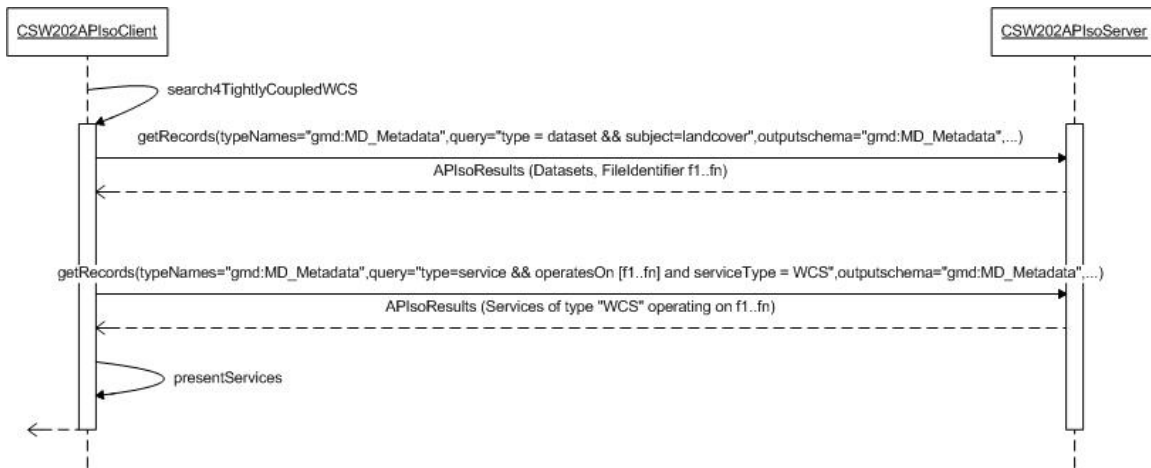

**Figure 17: Search for WCS tightly-coupled with “landcoverage” datasets (schematic)**

With the queryable properties ‘OperatesOnIdentifier’ and ‘OperatesOnName’ it is now possible to query for tightly-coupled services that can execute a specific operation (e.g. OperatesOnName = ‘GetFeatureInfo’) on a specific dataset (e.g. OperatesOnIdentifier = ‘5a389ad2-22dd-11d1-aa77-002035b29093’).

#### Filter Example:

```

<GetRecords xmlns="http://www.opengis.net/cat/csw/2.0.2"
  xmlns:ogc="http://www.opengis.net/ogc"
  xmlns:gmd="http://www.isotc211.org/2005/gmd"
  xmlns:apiso="http://www.opengis.net/cat/csw/apiso/1.0"
  xmlns:ows="http://www.opengis.net/ows"
  xmlns:xsd="http://www.w3.org/2001/XMLSchema"
  xmlns:dc="http://purl.org/dc/elements/1.1/"
  xmlns:dct="http://purl.org/dc/terms/" xmlns:gml="http://www.opengis.net/gml"
  xmlns:xsi="http://www.w3.org/2001/XMLSchema-instance"
  xsi:schemaLocation="http://www.opengis.net/cat/csw/2.0.2

```

```

  ..\cat\csw\2.0.2\CSW-discovery.xsd" service="CSW" version="2.0.2"
  resultType="results" outputFormat="application/xml"
  outputSchema="http://www.isotc211.org/2005/gmd" startPosition="1"
  maxRecords="5">
    <DistributedSearch hopCount="1"/>
    <Query typeNames="gmd:MD_Metadata">
      <ElementSetName typeNames="">brief</ElementSetName>
      <Constraint version="1.0.0">
        <ogc:Filter>
          <ogc:And>
            <ogc:PropertyIsEqualTo>
              <ogc:PropertyName>apiso:type</ogc:PropertyName>
                <ogc:Literal>service</ogc:Literal>
              </ogc:PropertyIsEqualTo>
            </ogc:PropertyIsEqualTo>
          </ogc:And>
        </ogc:Filter>
      </Constraint>
    </Query>
  </GetRecords>

```

## OGC 07-045r2

```
<ogc:PropertyName>apiso:ServiceType</ogc:PropertyName>
    <ogc:Literal>WMS</ogc:Literal>
</ogc:PropertyIsEqualTo>
<ogc:PropertyIsEqualTo>

<ogc:PropertyName>apiso:OperatesOnIdentifier</ogc:PropertyName>
    <ogc:Literal>5a389ad2-22dd-11d1-aa77-
002035b29093</ogc:Literal>
    </ogc:PropertyIsEqualTo>
<ogc:PropertyIsEqualTo>

<ogc:PropertyName>apiso:OperatesOnWithOpName</ogc:PropertyName>

<ogc:Literal>GetFeatureInfo</ogc:Literal>
    </ogc:PropertyIsEqualTo>
<ogc:PropertyIsGreaterThanOrEqualTo>

<ogc:PropertyName>apiso:CreationDate</ogc:PropertyName>
    <ogc:Literal>2004-01-01</ogc:Literal>
    </ogc:PropertyIsGreaterThanOrEqualTo>
    </ogc:And>
  </ogc:Filter>
</Constraint>
</Query>
</GetRecords>
```

This filter expression queries for catalogue records where *serviceType* is *WMS* and the service instance can operate with a *GETFEATUREINFO* operation on a dataset record with identifier equals to '5a389ad2-22dd-11d1-aa77-002035b29093'. Furthermore the constraint added to this query (*CreationDate* >= 2004-01-01) narrows the list of candidate service records.

In an AND connected filter-part, all attributes (values) refer to the same metadata entity, e.g.:

ServiceType = 'WFS' and OperatesOnIdentifier= <identifier1> and OperatesOnName = 'Update'

In this example the catalog service should **not** query for a WFS operating on <identifier1> that also has an UPDATE-Operation; rather it should query for a WFS, that operates on <identifier1> by using the UPDATE-Operation.

Example 2: An 'and' connected filter-part of the form:

ServiceType = 'WFS' and OperatesOnIdentifier = <identifier1> and  
OperatesOnIdentifier = <identifier2> and OperatesOnName = 'Update' and  
OperatesOnName = 'Insert'

In this example the catalog should **not** query for a WFS, operating on <identifier1> and <identifier2> that also has an UPDATE- and an INSERT-Operation'; rather it should query for a WFS that operates on <identifier1> and <identifier2> and can therefore apply the UPDATE- and the INSERT-Operation to the datasets.



With the CouplingType attribute, it is possible to search for services according to their data coupling type.

## Annex G (informative)

### Example requests/responses

#### G.1 GetRecords request

Example for outputschema = <http://www.opengis.net/cat/csw/2.0.2> and typeName = csw:Record

```
<GetRecords xmlns="http://www.opengis.net/cat/csw/2.0.2"
xmlns:csw="http://www.opengis.net/cat/csw/2.0.2"
xmlns:ogc="http://www.opengis.net/ogc" xmlns:ows="http://www.opengis.net/ows"
xmlns:xsd="http://www.w3.org/2001/XMLSchema"
xmlns:dc="http://purl.org/dc/elements/1.1/"
xmlns:dct="http://purl.org/dc/terms/" xmlns:gml="http://www.opengis.net/gml"
xmlns:xsi="http://www.w3.org/2001/XMLSchema-instance" service="CSW"
version="2.0.2" resultType="results" outputFormat="application/xml"
outputSchema="http://www.opengis.net/cat/csw/2.0.2" startPosition="1"
maxRecords="5">
  <Query typeName="csw:Record">
    <ElementSetName typeName="">brief</ElementSetName>
    <Constraint version="1.1.0">
      <ogc:Filter>
        <ogc:And>
          <ogc:PropertyIsLike escapeChar="\ " singleChar="?"
wildCard="*">
            <ogc:PropertyName>dc:title</ogc:PropertyName>
            <ogc:Literal>*spectra*</ogc:Literal>
          </ogc:PropertyIsLike>
          <ogc:PropertyIsEqualTo>
            <ogc:PropertyName>dc:type</ogc:PropertyName>
            <ogc:Literal>dataset</ogc:Literal>
          </ogc:PropertyIsEqualTo>
          <ogc:Intersects>
            <ogc:PropertyName>ows:BoundingBox</ogc:PropertyName>
            <gml:Envelope>
              <gml:lowerCorner>14.05 46.46</gml:lowerCorner>
              <gml:upperCorner>17.24 48.42</gml:upperCorner>
            </gml:Envelope>
          </ogc:Intersects>
        </ogc:And>
      </ogc:Filter>
    </Constraint>
  </Query>
</GetRecords>
```

Example for outputschema = <http://www.isotc211.org/2005/gmd> and typeName = gmd:MD\_Metadata

```
<GetRecords xmlns="http://www.opengis.net/cat/csw/2.0.2"
xmlns:ogc="http://www.opengis.net/ogc"
xmlns:gmd="http://www.isotc211.org/2005/gmd"
```

```

xmlns:apiso="http://www.opengis.net/cat/csw/apiso/1.0"
xmlns:ows="http://www.opengis.net/ows"
xmlns:xsd="http://www.w3.org/2001/XMLSchema"
xmlns:dc="http://purl.org/dc/elements/1.1/"
xmlns:dct="http://purl.org/dc/terms/" xmlns:gml="http://www.opengis.net/gml"
xmlns:xsi="http://www.w3.org/2001/XMLSchema-instance" service="CSW"
version="2.0.2" resultType="results" outputFormat="application/xml"
outputSchema="http://www.isotc211.org/2005/gmd" startPosition="1"
maxRecords="5">
  <DistributedSearch hopCount="2"/>
  <Query typeNames="gmd:MD_Metadata">
    <ElementSetName typeNames="">brief</ElementSetName>
    <Constraint version="1.1.0">
      <ogc:Filter>
        <ogc:And>
          <ogc:PropertyIsLike escapeChar="\\"
singleChar="?" wildCard="*">
            <ogc:PropertyName>apiso:title</ogc:PropertyName>
              <ogc:Literal>*soil*</ogc:Literal>
            </ogc:PropertyIsLike>
          <ogc:Or>
            <ogc:PropertyIsEqualTo>
              <ogc:PropertyName>apiso:type</ogc:PropertyName>
                <ogc:Literal>dataset</ogc:Literal>
              </ogc:PropertyIsEqualTo>
            <ogc:PropertyIsEqualTo>
              <ogc:PropertyName>apiso:type</ogc:PropertyName>
                <ogc:Literal>datasetcollection</ogc:Literal>
              </ogc:PropertyIsEqualTo>
            </ogc:Or>
          <ogc:PropertyIsGreaterThanOrEqualTo>
            <ogc:PropertyName>apiso:CreationDate</ogc:PropertyName>
              <ogc:Literal>2006-06-09</ogc:Literal>
            </ogc:PropertyIsGreaterThanOrEqualTo>
          <ogc:PropertyIsEqualTo>
            <ogc:PropertyName>apiso:crs</ogc:PropertyName>
              <ogc:Literal>urn:ogc:def:crs:EPSG:6.3:4326</ogc:Literal>
            </ogc:PropertyIsEqualTo>
          <ogc:Intersects>
            <ogc:PropertyName>apiso:BoundingBox</ogc:PropertyName>
              <gml:Envelope>
                <gml:lowerCorner>14.05
46.46</gml:lowerCorner>
                <gml:upperCorner>17.24
48.42</gml:upperCorner>
              </gml:Envelope>
            </ogc:Intersects>
          </ogc:And>
        </ogc:Filter>
      </Constraint>
    </Query>
  </DistributedSearch>

```

```

    </Query>
</GetRecords>

```

## G.2 GetRecords response

```

<GetRecordsResponse xmlns="http://www.opengis.net/cat/csw/2.0.2"
xmlns:ogc="http://www.opengis.net/ogc" xmlns:ows="http://www.opengis.net/ows"
xmlns:xsi="http://www.w3.org/2001/XMLSchema-instance"
xsi:schemaLocation="http://www.opengis.net/cat/csw/2.0.2
..\cat\csw\2.0.2\CSW-discovery.xsd">
  <RequestId>http://www.altova.com</RequestId>
  <SearchStatus timestamp="2006-12-17T09:30:47-05:00"/>
  <SearchResults resultSetId="http://www.altova.com" elementSet="brief"
recordSchema="http://www.altova.com" numberOfRecordsMatched="1"
numberOfRecordsReturned="1" nextRecord="1">
    <MD_Metadata xmlns="http://www.isotc211.org/2005/gmd"
xmlns:gco="http://www.isotc211.org/2005/gco"
xmlns:gml="http://www.opengis.net/gml">
      <fileIdentifier>
        <gco:CharacterString>2345-aa453-ade456</gco:CharacterString>
      </fileIdentifier>
      <language>
        <gco:CharacterString>eng</gco:CharacterString>
      </language>
      <hierarchyLevel>
        <MD_ScopeCode
codeList="http://www.isotc211.org/2005/resources/codeList.xml#MD_ScopeCode"
codeListValue="dataset"/>
      </hierarchyLevel>
      <contact>
        <CI_ResponsibleParty>
          <organisationName>
            <gco:CharacterString>US National Geospatial-
Intelligence Agency</gco:CharacterString>
          </organisationName>
          <role>
            <CI_RoleCode
codeList="http://www.isotc211.org/2005/resources/codeList.xml#CI_RoleCode"
codeListValue="publisher"/>
          </role>
        </CI_ResponsibleParty>
      </contact>
      <!-- Date the metadata was created -->
      <dateStamp>
        <gco:Date>2004-03-14</gco:Date>
      </dateStamp>
      <metadataStandardName>
        <gco:CharacterString>ISO19115</gco:CharacterString>
      </metadataStandardName>
      <metadataStandardVersion>
        <gco:CharacterString>2003/Cor.1:2006</gco:CharacterString>
      </metadataStandardVersion>
      <!-- IDENTIFICATION INFORMATION -->
      <identificationInfo>
        <MD_DataIdentification>
          <citation>
            <CI_Citation>
              <title>

```

```

<gco:CharacterString>VMAPLV0</gco:CharacterString>
</title>
<date>
  <CI_Date>
    <date>
      <gco:Date>2000-09-
03</gco:Date>
    </date>
  </date>
  <dateType>
    <CI_DateTypeCode
codeList="http://www.isotc211.org/2005/resources/codeList.xml#CI_DateTypeCode"
codeListValue="publication"/>
  </dateType>
</CI_Date>
</date>
<identifier>
  <MD_Identifier>
    <code>

<gco:CharacterString>String</gco:CharacterString>
    </code>
  </MD_Identifier>
</identifier>
<citedResponsibleParty>
  <CI_ResponsibleParty
id="ID00010">
    <organisationName>

    <gco:CharacterString>US National Geospatial-Intelligence
Agency</gco:CharacterString>
    </organisationName>
    <role/>
  </CI_ResponsibleParty>
</citedResponsibleParty>
</CI_Citation>
</citation>
<abstract>
  <gco:CharacterString>Vector Map: a general
purpose database design to support GIS applications</gco:CharacterString>
</abstract>
<pointOfContact>
  <CI_ResponsibleParty id="ID00001">
    <organisationName>
      <gco:CharacterString>US National
Geospatial-Intelligence Agency</gco:CharacterString>
    </organisationName>
    <role>
      <CI_RoleCode
codeList="http://www.isotc211.org/2005/resources/codeList.xml#CI_RoleCode"
codeListValue="originator"/>
    </role>
  </CI_ResponsibleParty>
</pointOfContact>
<language>
  <gco:CharacterString>eng</gco:CharacterString>
</language>
<topicCategory>

```

## OGC 07-045r2

```
<MD_TopicCategoryCode>boundaries</MD_TopicCategoryCode>
  </topicCategory>
</topicCategory>

<MD_TopicCategoryCode>elevation</MD_TopicCategoryCode>
  </topicCategory>
  <extent>
    <EX_Extent>
      <geographicElement>
        <EX_GeographicBoundingBox>
          <westBoundLongitude>
            <gco:Decimal>-
180.00</gco:Decimal>
            </westBoundLongitude>
          <eastBoundLongitude>
            </eastBoundLongitude>
          <southBoundLatitude>
            <gco:Decimal>180.00</gco:Decimal>
            </southBoundLatitude>
          <northBoundLatitude>
            <gco:Decimal>90.00</gco:Decimal>
            </northBoundLatitude>
        </EX_GeographicBoundingBox>
      </geographicElement>
    </EX_Extent>
  </extent>
</MD_DataIdentification>
</identificationInfo>
</MD_Metadata>
</SearchResults>
</GetRecordsResponse>
```

### G.3 GetRecordById request

```
<GetRecordById xmlns="http://www.opengis.net/cat/csw/2.0.2"
xmlns:xsi="http://www.w3.org/2001/XMLSchema-instance" service="CSW"
version="2.0.2" outputSchema="http://www.opengis.net/cat/csw/2.0.2">
  <Id>efc40467-284d-4fee-af2a-522c717e7165</Id>
  <ElementSetName>full</ElementSetName>
</GetRecordById>
```

### G.4 DescribeRecord request

```
<DescribeRecord xmlns="http://www.opengis.net/cat/csw/2.0.2"
xmlns:xsd="http://www.w3.org/2001/XMLSchema"
xmlns:gmd="http://www.isotc211.org/2005/gmd"
xmlns:xsi="http://www.w3.org/2001/XMLSchema-instance"
xsi:schemaLocation="http://www.opengis.net/cat/csw/2.0.2
..\cat\csw\2.0.2\CSW-discovery.xsd"
schemaLanguage="http://www.w3.org/2001/XMLSchema" service="CSW"
version="2.0.2">
```

```
<TypeName>gmd:MD_Metadata</TypeName>  
</DescribeRecord>
```

## G.5 Harvest request

```
<Harvest xmlns="http://www.opengis.net/cat/csw/2.0.2"  
xmlns:ogc="http://www.opengis.net/ogc"  
xmlns:gmd="http://www.isotc211.org/2005/gmd"  
xmlns:ows="http://www.opengis.net/ows"  
xmlns:xsd="http://www.w3.org/2001/XMLSchema"  
xmlns:dc="http://purl.org/dc/elements/1.1/"  
xmlns:dct="http://purl.org/dc/terms/" xmlns:gml="http://www.opengis.net/gml"  
xmlns:xsi="http://www.w3.org/2001/XMLSchema-instance" service="CSW"  
version="2.0.2">  
  <Source>http://www.yourserver.com/metadata.xml</Source>  
  <ResourceType>http://www.isotc211.org/schemas/2005/gmd/</ResourceType>  
  <ResourceFormat>application/xml</ResourceFormat>  
  <HarvestInterval>P7D</HarvestInterval>  
</Harvest>
```